

2.1. Designation Code for Semiconductors

1. For types predominantly used in radio or television sets and magnetic recorders the type designation code consists of
2 letters and 3 numerals (Standard-Types)
2. For types predominantly used for applications other than those mentioned under 1., i. e. primarily for industrial purposes, the type designation code consists of
3 letters and 2 numerals (Industrial-Types)

The meaning of the letters is as follows:

First letter

- A Base material germanium (material with a band gap of 0.6 to 1.0 eV)
- B Base material silicon (material with a band gap of 1.0 to 1.3 eV)
- C III-V-material, e.g. gallium arsenide (material with a band gap of 1.3 eV and more).
- D Material with a band gap of less than 0.6 eV, e.g. indium antimonide
- R Semiconductor material for photo-conductive cells and hall generators

Second letter

- A Diode (except tunnel, power, zener diodes and radiation-sensitive diode, reference diode and voltage control, tuner diode)
- B Variable capacitance diode
- C Transistor for AF application ($R_{thJcase} < 15 \text{ k/W}$)
- D Power transistor for AF application ($R_{thJcase} > 15 \text{ K/W}$)
- E Tunnel diode
- F Transistor for RF application ($R_{thJcase} > 15 \text{ K/W}$)
- H Hall field probe
- K Hall generator in an open magnetic circuit (e.g. magnetogram or signal probe)
- L Power transistor for RF application ($R_{thJcase} < 15 \text{ K/W}$)
- M Hall generator in a closed magnetic circuit (e.g. hall modulator and hall multiplier)
- P Radiation-sensitive semiconductor component (e.g. photo voltaic cell)
- Q Radiation generating semiconductor component (e.g. light emitting diode)
- R Electrically triggered control or switching components having a breakdown characteristic ($R_{thJcase} > 15 \text{ K/W}$), e.g. thyristor tetrode
- S Transistor for switching applications ($R_{thJcase} > 15 \text{ K/W}$)
- T Electrically or light triggered control and switching components having a breakdown characteristic ($R_{thJcase} < 15 \text{ K/W}$), e.g. thyristor tetrode, controllable power rectifier
- U Power transistor for switching applications ($R_{thJcase} < 15 \text{ K/W}$)
- X Multiplier-diodes, e.g. varactor, step-recovery diode
- Y Power diode, rectifying diode, booster diode
- Z Reference or voltage regulator diode Z-diode (formerly zener diode) For the types described under 2, the letters Z, Y or X are used as a **third letter**.

The numbers following the letters are only used for consecutive numbering, they have no technical significance.

2.2. Explanation of the Terms „Maximum Ratings” and „Characteristics”

Maximum Ratings

The maximum ratings indicated in the data sheets are absolute maximum values. If one of the maximum values is exceeded, this may result in the destruction of the semiconductor component even if the other maximum values are not fully utilized. Unless otherwise stated, the maximum ratings apply to 25 °C.

Characteristics

Properties characterizing the behavior of a semiconductor component under defined test conditions are termed „characteristics”.

Static characteristics apply to the DC behavior and dynamic characteristics to the behavior in case of AC or pulse operation.

Characteristics (numerical values or curves) are not to be taken as the data of a single component because of the spread shown by each type. The ranges of spread are indicated either by numerical values or graphs.

2.3. Lettering Conventions and List of the Symbols and Terms Used

The current, voltage, power (AC, DC, or typical values) and resistance types (AC or DC values) are indicated by using capital and small letters for the symbols.

2.3.1. Quantity Symbols

The instantaneous values of quantities varying with time are indicated by small letters.

Examples: i, v, p

Capital letters are used for DC, average, and r. m. s. values as well as for maximum values of periodical functions of the current, the voltage and the power, i. e. for constant quantities.

Examples: I, V, P

Subscripts for Quantity Symbols

the following subscripts are used:

E, e	Emitter
B, b	Base
C, c	Collector
F, f	Forward direction (diode operated in forward direction)
R, r	Reverse direction (diode operated in reverse direction)
M, m	Maximum value
av	Average value

The subscripts for maximum and average values may be omitted, provided confusion with other values is impossible.

Total values (instantaneous values, DC values, average, r. m. s., and maximum values) referred to a zero point are indicated by subscripts with capital letters.

Examples: $i_c, I_C, v_{BE}, V_{BE}, p_C, P_C$

Subscripts with small letters are used for the values of variable components (e. g. for instantaneous values, maximum and r. m. s. values referred to an arithmetical mean).

Examples: $i_{cr}, I_{cr}, v_{ber}, V_{ber}, p_{cr}, P_{cr}$

To distinguish between maximum, average, and r. m. s. values, further subscripts may be added. The following abbreviations are recommended:

Maximum values M, m
Average values (arithmetical means) Av, av

Examples: $I_{CM}, I_{CAV}, I_{cm}, I_{cav}$

Maximum values may also be indicated by placing the symbol " \wedge " over the letter.

Examples: \hat{I}_C, \hat{I}_c

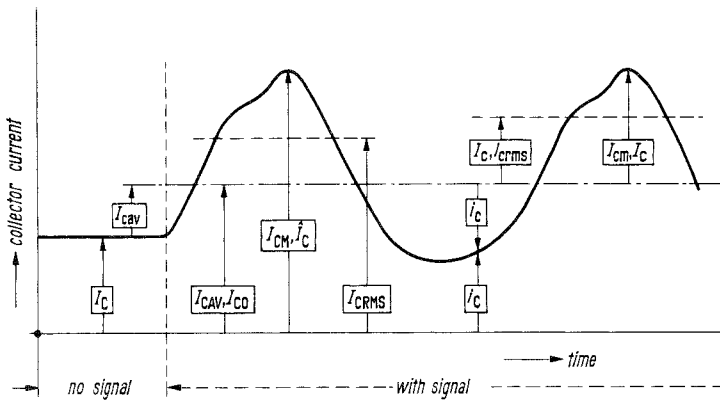

- I_C DC value, no signal
- I_{CAV} (Arithmetical) mean of the total current (referred to zero)
- I_{CM}, \hat{I}_C Maximum total value of the current (referred to zero)
- I_{CRMS} R. m. s. total value of the current (referred to zero)
- I_{cav} (Arithmetical) mean of the variable component superimposed on the closed-circuit DC I_C (referred to the DC no-signal value I_C)
- I_C, I_{Crms} R. m. s. value of the variable component (referred to the arithmetical mean I_{CAV})
- I_{cm}, \hat{I}_c Maximum value of the variable component (referred to the arithmetical mean I_{CAV})
- i_C Instantaneous total value (referred to zero)
- i_c Instantaneous value of the variable component (referred to the arithmetical mean I_{CAV})

The following relations exist for the quantities indicated in the above diagram:

$$\begin{aligned}
 I_{CAV} &= I_C + I_{cav} \\
 \hat{I}_{CM} &= I_C + I_{cm} = I_{CAV} + I_{cm} \\
 I_{CRMS} &= \sqrt{I_{CAV}^2 + I_{Crms}^2} \\
 I_C &= I_{CAV} + i_c
 \end{aligned}$$

Basic Symbols Chart

The following chart provides information as to whether capital or small letters have to be used for the symbols. This is further explained by the diagram below.

		Symbols	
		<i>i, v, p</i>	<i>I, V, P</i>
Subscripts	e	Instantaneous value of the variable component	R. m. s., average, and maximum value of the variable component
	b		
	c		
	f		
	r		
	m	Instantaneous total value (as referred to zero)	DC value, average, r. m. s. and maximum value (as referred to zero)
	av		
	E		
	B		
	C		
F			
R			
M			
AV			

Conventions for Subscripts Sequence

Voltages

As a rule, two subscripts are used to indicate the points between which the voltage is measured.

Positive numerical values of the voltages correspond to positive potentials on the point indicated by the first subscript as referred to the point indicated by the second subscript (point of reference).

The second subscript may be omitted if this cannot lead to confusion or misunderstandings.

A supply voltage may be indicated by repeating the subscript of the terminal concerned.

Examples: V_{EEB} , V_{BBB} , V_{CCE}

Currents

As a rule, at least one subscript is used. Positive numerical values of the current correspond to positive currents entering the component at the terminal indicated by the first subscript.

Subscripts for Terminals

In the case of components having more than one terminal of the same type, the subscripts for the terminals may be modified by suffixing a number to them, subscript and suffix having to be written on the same line.

Example: V_{B2-E} (voltage between second base terminal and emitter)

If several components form an assembly, the subscripts for the terminals may be modified by prefixing a number to them, subscript and prefix having to be written on the same line.

Example: V_{1B-2B} (voltage between the base of the first component and the base of the second component)

Impedances, Admittances, Four-Terminal Network Coefficients, etc.

Symbols Used for Impedances, Admittances, Four-Terminal Network Coefficients, etc.

Small letters with appropriate subscripts are used for four-terminal network coefficients as well as impedances, admittances, capacitances, inductances, etc., which describe the properties of the component.

Examples: h_{11b} , h_{11e} , z_{21b} , y_{22c}

Capital letters with appropriate subscripts are used for four-terminal network coefficients as well as impedances, admittances, capacitances, inductances, etc. of external networks or of networks of which the component forms a part.

Examples: H_{11b} , H_{11e} , Z_{21b} , Y_{22c}

Capital-letter subscripts are used for DC values (including large-signal values) of four-terminal network coefficients as well as impedances, admittances, etc.

The DC value is the slope of the straight line from the origin of the coordinate system to the operating point on the characteristic of the component.

Examples: r_B , h_{11B} , h_{FE}

Small-letter subscripts are used for AC values (small-signal values) of four-terminal network coefficients as well as impedances, admittances, capacitances, inductances, etc.

Examples: r_{bb} , h_{11b} , h_{ie}

The first subscript or the first pair of subscripts written in the manner customary for matrix elements is used for determining the elements of a four-terminal network matrix.

11 (or i) = input

21 (or f) = forward transfer

22 (or o) = output

12 (or r) = reverse transfer

Example: $V_1 = h_{11} \cdot I_1 + h_{12} \cdot V_2$

$I_2 = h_{21} \cdot I_1 + h_{22} \cdot V_2$

Note:

When written in matrix representation (or as elements of matrices) the voltage and current symbols are supplemented by a subscript consisting of a single numeral.

Subscript 1 = input

Subscript 2 = output

The second subscript or the subscript following the pair of numerals indicates the basic circuit.

If the common terminal is self-evident, the second subscript may be omitted.

e = common emitter
b = common base
c = common collector

Example (common base):

$I_1 = y_{11b} \cdot V_{1b} + y_{12b} \cdot V_{2b}$

$I_2 = y_{21b} \cdot V_{1b} + y_{22b} \cdot V_{2b}$

If the transistor is described by its four-terminal network equivalent, it is recommended to fix the direction arrows for the input and output currents in the direction of the four-terminal network.

2.3.2. Alphabetical List of Symbols Used

<i>a</i>	Turn-off base current factor (T_r)
<i>A</i>	Anode
<i>A</i>	Static current transfer ratio in common base circuit
<i>AQL</i>	Acceptable quality level
α	Dynamic short-circuit forward current transfer ratio in common base circuit ($\alpha = -h_{21b}$)
α_0	Dynamic short-circuit forward current transfer ratio in common base circuit at $f = 1$ kHz
<i>b</i>	Imaginary component of the y -parameters
b_{11}	Imaginary component of the short-circuit input admittance (of parameter Y_{11})
b_{12}	Imaginary component of the short-circuit reverse transconductance (of parameter y_{12})
b_{21}	Imaginary component of the short-circuit forward transconductance (of parameter y_{21})
b_{22}	Imaginary component of the short-output admittance (of parameter y_{22})
<i>B</i>	Base terminal
$B = h_{FE}$	Forward current transfer ratio, static, in common emitter circuit
β	Dynamic short-circuit forward current transfer ratio in common emitter circuit ($\beta = h_{21e}$)
$\beta_0 = h_{fe}$	Dynamic short-circuit forward current transfer ratio in common emitter circuit at $f = 1$ kHz
<i>C, c</i>	Collector terminal
<i>C</i>	Capacitance
$C_{b'c}$	Collector-junction capacitance
$C_{b'e}$	Emitter diffusion capacitance
C_C	Collector-junction capacitance (in general)
C_{case}	Case capacitance (in general)
C_{cb}	Collector-base-case capacitance
C_{CBO}	Collector-base capacitance (including case capacitance) with emitter open ($I_E = 0$)
$C_{c'b}$	Collector-junction capacitance
$C_{c'b'}$	Collector-junction capacitance
C_{ce}	Collector-emitter-case capacitance
C_D	Total diode capacitance
C_{eb}	Emitter-base-case capacitance
$C_{eb'}$	Emitter diffusion capacitance
C_{EBO}	Emitter-base capacitance (including case capacitance) with collector open ($I_C = 0$)
C_j	Junction capacitance of diodes
C_N	Neutralisation capacitance
C_n	Standardized capacitance
C_L	Load capacitance
C_p	Parallel capacitance
C_{th}	Thermal capacity (irrespective of heat dissipation to the environment)
C_{11}	Capacitance of the short-circuit input admittance (of parameter y_{11})
C_{12}	Capacitance of the short-circuit reverse transconductance (of parameter y_{12})
C_{21}	Capacitance of the short-circuit forward transconductance (of parameter y_{21})
C_{22}	Capacitance of the short-circuit output admittance (of parameter y_{22})

Di	Abbreviation for “diode”
E	Emitter terminal
E_{tr}	Transistor energy loss
f	Frequency
f_g	Cutoff frequency
f_{α}	Cutoff frequency of the short-circuit forward current transfer ratio in common base circuit
f_{β}	Cutoff frequency of the short-circuit forward current transfer ratio in common emitter circuit
$f_{\beta 1}$	Frequency at which $\beta = 1$
f_{max}	Maximum oscillation frequency
f_T	Current gain-bandwidth product (extrapolated cutoff frequency for $\beta = 1$; $f_T \approx f_{\beta 1}$)
g	Real component of the y -parameters
g	Admittance (instantaneous value)
$g_{b'c}$	Collector admittance
$g_{b'e}$	Emitter admittance
g_{ce}	Collector-emitter admittance
g_m	Internal transconductance
g_{th}	Coefficient thermal conductivity (total instantaneous value of thermal conduction)
$g_{th\ case}$	Coefficient of thermal conductivity (total instantaneous value of thermal conduction) between heat source and case, with infinitely good heat dissipation from the case ($T_{case} = T_{amb}$)
g_{11}	Real component of the short-circuit input admittance (of parameter y_{11})
g_{12}	Real component of the short-circuit reverse transconductance (of parameter y_{12})
g_{21}	Real component of the short-circuit forward transconductance (of parameter y_{21})
g_{22}	Real component of the short-circuit output admittance (of parameter y_{22})
G	Admittance (DC or average value)
G_A	Anode gate
G_g	Internal admittance of generator
G_K	Cathode gate
G_L	Load admittance
G_p	Power gain
G_{pb}	Power gain in common base circuit
G_{pe}	Power gain in common emitter circuit
$G_{p\ opt}$	Optimum power gain
$G_{pb\ inv}$	Reverse power loss
$G_{pb\ opt}$	Optimum power gain in common base circuit
$G_{pe\ opt}$	Optimum power gain in common emitter circuit
G_{th}	Coefficient of thermal conductivity (thermal conduction constant)
G_{thJamb}	Coefficient of thermal conductivity (thermal conduction constant) between junction (heat source) and static ambient air
$G_{thJcase}$	Coefficient of thermal conductivity (thermal conduction constant) between heat source and case, with infinitely good heat dissipation from the case $T_{case} = T_{amb}$)
G_{thL}	Coefficient of thermal conductivity (thermal conduction constant) between junction (heat source) and static ambient air when using a cooling plate of defined size

γ	Dynamic short-circuit forward current transfer ratio in common collector circuit
h	Parameter of the hybrid matrix (h -matrix)
h_{11}	Short-circuit input impedance
h_{12}	Open-circuit reverse voltage transfer ratio
h_{21}	Short-circuit forward current transfer ratio
h_{22}	Open-circuit output admittance
i_{AM}	Maximum recording current (peak value; Hd)
i_{BM}	Maximum base current (peak value)
i_{CM}	Maximum collector current (peak value)
i_{EM}	Maximum emitter current (peak value)
i_{FM}	Maximum forward current (peak value; Di)
i_{FS}	Surge current, maximum 1 sec
i_1	Input AC
i_{1M}	Maximum control current (peak value)
i_2	Output AC (in general)
I_A	Recording current (DC or average value)
I_A	Anode current
I_B	Base current (DC or average value)
I_{BAV}	Base current at stated integration time t_{av}
I_{B1}	Control current
I_{B2}	Turn-off base current
I_C	Collector current (DC or average value)
I_{CBO}	Collector-base cutoff current with emitter open ($I_E = 0$)
I_{CEO}	Collector-emitter cutoff current with base open ($I_B = 0$)
I_{CER}	Collector-emitter cutoff current with a resistance R_{BE} between base and emitter
I_{CES}	Collector-emitter cutoff current with short-circuited emitter diode ($V_{BE} = 0$)
I_{CEV}	Collector-emitter cutoff current with blocked emitter diode
I_E	Emitter current (DC or average value)
I_{EAV}	Emitter current at stated integration time t_{av}
I_{EBO}	Emitter-base cutoff current with collector open ($I_C = 0$)
I_F	Forward current (DC or average value)
I_K	Short-circuit current
I_O	Rectified current
I_R	Reverse current
k	Distortion factor
L	Inductance
L_S	Series inductance
m	In a subscript: maximum (peak value)
max	In a subscript: maximum (e. g. upper limit of spread)
min	In a subscript: maximum (e. g. lower limit of spread)
M	In a subscript: maximum (peak value)
N	Number of turns
NF	Noise figure
NF_c	Mixing noise figure
$P; p$	Power dissipation
P_a	Amplifier output power

P_L	Amplifier dissipation power
P_1	Pulse dissipation
P_{tot}	Total power dissipation
φ	Phase angle of the y -parameters
φ	Slope angle of the linearized and normalized Hall-effect device characteristic
φ_{11}	Phase angle of the short-circuit input admittance (of parameter y_{11})
φ_{12}	Phase angle of the short-circuit reverse transconductance (of parameter y_{12})
φ_{21}	Phase angle of the short-circuit forward transconductance (of parameter y_{21})
φ_{22}	Phase angle of the short-circuit output admittance (of parameter y_{22})
Q	Quality factor
r	Resistance (instantaneous value)
$r_{bb'}$	Base series resistance
$r_{bb'} C_{b'c}$	Feedback time constant
$r_{cc'}$	Collector series resistance
$r_{eb'}$	Emitter series resistance
R	Resistance (DC or average value)
R_{BB}	Base dropping resistor
R_{BE}	Resistance between base and emitter
R_{CC}	Collector dropping resistor
R_d	Loss resistance (Di)
R_{EE}	Emitter dropping resistor
R_g	Internal resistance of generator
R_L	Load resistance
R_{LL}	Optimum load resistance
R_{min}	Minimum value of thermal resistance under continuous load
R_S	Series resistance
R_{th}	Thermal resistance
$R_{th,case}$	Thermal resistance between junction (heat source) and case with infinitely good heat dissipation from the case ($T_{case} = T_{amb}$)
R_{thc}	Thermal resistance of a chassis (cooling plate not heat sink)
R_{thL}	Thermal resistance between junction (heat source) and static ambient air when using a cooling plate of defined size
$R_{th,Jamb}$	Thermal resistance between junction (heat source) and static ambient air
R_V	Dropping resistor
t	Time
t	Pulse length
t_{av}	Integration time
t_d	Delay time
t_f	Fall time
t_{fr}	Forward recovery time (Transistors); forward delay time (Diodes)
th	In a subscript: thermal
t_{off}	Switch-off time
t_{on}	Turn-on time ($t_{on} = t_d + t_r$)
t_r	Rise time
t_{rr}	Reverse recovery time; reverse delay time
t_s	Storage time
t_{vu}	Approximate value of the voltage-dependent delay time
T	Temperature
T_{amb}	Ambient temperature
T_{case}	Case temperature

T_j	Junction temperature
T_T	Abbreviation for "transistor"
T_S	Storage temperature
ΔT	Temperature difference
τ	Cycle duration
τ	Time constant
τ_s	Storage time constant
τ_{th}	Thermal time constant (time in which a temperature difference ΔT changes by $\Delta T/e$)
\ddot{u}	Overdriving factor
v	Voltage (instantaneous value)
V_{FM}	Forward voltage, maximum (peak value)
V_{RF}	Input radio frequency voltage
V_{RM}	Maximum reverse voltage (peak value; Di)
V_{RS}	Surge voltage, maximum 1 sec (Di)
v_1	Input AC voltage
v_2	Output AC voltage
V	Voltage (DC or average value)
$V_a (V_A)$	Output voltage (measured peak-to-peak)
V_{batt}	Battery voltage
V_{BB}	Base operating voltage
V_{BE}	Base-emitter voltage
V_{BEfl}	Emitter open circuit DC voltage
V_{BEF}	Emitter forward voltage
$V_{(BR) CBO}$	Collector-base breakdown voltage
$V_{(BR) CEO}$	Collector-emitter breakdown voltage
$V_{(BR) EBO}$	Emitter-base breakdown voltage
V_{CB}	Collector-base voltage
V_{CBO}	Collector-base voltage with emitter open ($I_E = 0$)
V_{CC}	Collector operating voltage
V_{CE}	Collector-emitter voltage
V_{CEO}	Collector-emitter reverse voltage base open ($I_B = 0$)
V_{CER}	Collector-emitter reverse voltage with a resistor between base and emitter
V_{CES}	Collector-emitter voltage with short-circuited emitter diode ($V_{BE} = 0$)
$V_{CE sat}$	Collector-emitter saturation voltage
V_{CEV}	Collector-emitter reverse voltage with blocked emitter diode
V_{DD}	Anode-cathode cut-off voltage
V_{EBO}	Emitter-base reverse voltage with collector open ($I_C = 0$)
V_E	Input voltage
V_{EE}	Emitter operating voltage
V_F	Forward voltage
V_{FM}	Forward voltage (peak value)
V_L	Open-circuit voltage
V_O	Rectified voltage (Di)
V_{Oeff}	Output voltage, effective
V_{pt}	Function contact potential
V_R	Reverse voltage (Di)
V_{pp}	Peak-to-peak output voltage
V_i	Dynamically operating forward current transfer ratio
y	Parameter of the admittance matrix (y-matrix)

y_{11}	Short-circuit input admittance
y_{12}	Short-circuit reverse transconductance
y_{21}	Short-circuit forward transconductance
y_{22}	Short-circuit output admittance
Z_{12}	Reverse impedance with input open
Z_1	Input impedance (in general)
Z_2	Output impedance (in general)
ηV	Reverse-to-forward voltage ratio
ν	Duty cycle (Tr)
ω	Angular frequency $\omega = 2 \cdot \pi \cdot f$

2.3.3. Alphabetical List of Terms Used

Admittance (DC value or average value)	G
Admittance (instantaneous value)	g
Admittance matrix, parameter of	Y
Ambient temperature	T_{amb}
Amplifier output power	P_a
Angular frequency ($\omega = 2 \cdot \pi \cdot f$)	ω
Anode	A
Anode saturation voltage	$V_{AK sat}$
Anode current	I_A
Base current	I_B
Base current at stated integration time t_{av}	I_{BAV}
Base current, maximum	I_{BM}
Base dropping resistor	R_{BB}
Base-emitter voltage	V_{BE}
Base operating voltage	V_{BB}
Base series resistance	$r_{bb'}$
Base terminal	B
Battery voltage	V_{batt}
Breakdown voltage (i. e. collector-emitter $V_{(BR) CEO}$)	$V_{(BR)}$
Capacitance	C
Capacitance of the short-circuit forward transconductance (of parameter y_{21})	C_{21}
Capacitance of the short-circuit input admittance (of parameter y_{11})	C_{11}
Capacitance of the short-circuit output admittance (of parameter y_{22})	C_{22}
Capacitance of the short-circuit reverse transconductance (of parameter y_{12})	C_{12}
Capacitance, total, of diode	C_D
Case capacitance (in general)	C_{case}
Case capacitance, collector-base	C_{cb}
Case capacitance, collector-emitter	C_{ce}
Case capacitance, emitter-base	C_{eb}
Case temperature	T_{case}
Characteristics	
Coefficient of thermal conductivity (total instantaneous value of the thermal conduction)	$G_{th}; g_{th}$

Coefficient of thermal conductivity (total instantaneous value of the thermal conduction)	
between junction (heat source) and case, with infinitely good heat dissipation from the case ($T_{case} = T_{amb}$)	$G_{thJcase}$
Coefficient of thermal conductivity (thermal conduction constant) between junction (heat source) and static ambient air	$g_{thJcase}$
Coefficient of thermal conductivity (thermal conduction constant) between junction (heat source) and static ambient air when using a cooling plate of defined size	G_{thJamb}
Collector admittance	G_{thL}
Collector-base capacitance (including case capacitance)	$g_{b'c}$
Collector-base-case capacitance	C_{CBO}
Collector-base cutoff current with emitter open ($I_E = 0$)	C_{cb}
Collector-base reverse voltage with emitter open ($I_E = 0$)	I_{CBO}
Collector-base voltage	V_{CBO}
Collector current (DC or average value)	V_{CB}
Collector current maximum (peak value)	I_C
Collector current at stated integration time t_{av}	i_{CM}
Collector dropping resistor	I_{CAV}
Collector-emitter admittance	R_{CC}
Collector-emitter case capacitance	g_{ce}
Collector-emitter cutoff current with a resistance R_{BE} between base and emitter	C_{ce}
Collector-emitter cutoff current with base open ($I_B = 0$)	I_{CER}
Collector-emitter cutoff current with blocked diode	I_{CEO}
Collector-emitter reverse voltage with a resistor R_{BE} between base and emitter	I_{CEV}
Collector-emitter reverse voltage with base open ($I_B = 0$)	V_{CER}
Collector-emitter reverse voltage with blocked emitter diode	V_{CEO}
Collector-emitter saturation voltage	V_{CEV}
Collector-emitter voltage	$V_{CE sat}$
Collector-emitter voltage with short-circuited emitter diode ($V_{BE} = 0$)	V_{CE}
Collector-junction capacitance (in general)	V_{CES}
Collector-junction capacitance	C_C
Collector-junction capacitance	$C_{b'c'}$, $C_{b'c}$
Collector operating voltage	$C_{c'b'}$
Collector series resistance	V_{CC}
Collector terminal	$r_{cc'}$
Control current	C, c
Control current, maximum (peak value)	I_{B1}
Control field, magnetic	I_1
Current gain-bandwidth product	i_{1M}
Current generator, internal	B
Cutoff frequency	f_T
Cutoff frequency of the short-circuit forward current transfer ratio in common base circuit	α'
Cutoff frequency of the short-circuit forward current transfer ratio in common emitter circuit	f_g
Cycle duration	f_α
	f_β
	τ
DC resistance of recording winding	R_A
Delay time	t_d
Delay time, approximate value of the voltage-dependent	t_{vu}
Determinant of admittance (y) matrix	ΔY

Determinant of hybrid (h) matrix	Δh
Diode	D_i
Dissipation, pulse	P_i
Distortion factor	k
Dropping resistor	R_V
Duty cycle	ν
Dynamically operating forward current transfer ratio	V_i
Emitter admittance	$g_{b'e}$
Emitter-base-base capacitance	C_{eb}
Emitter-base cutoff current with collector open ($I_C = 0$)	I_{EBO}
Emitter-base reverse voltage with collector open ($I_C = 0$)	V_{EBO}
Emitter current (DC or average value)	I_E
Emitter current, maximum (peak value)	i_{EM}
Emitter current at stated integration time t_{av}	I_{EAV}
Emitter diffusion capacitance	$C_{b'e}, C_{eb}$
Emitter dropping resistor	R_{EE}
Emitter forward voltage	V_{BEF}
Emitter operating voltage	V_{EE}
Emitter series resistance	$r_{eb'}$
Emitter terminal	E, e
Fall time	t_f
Feedback time constant	$r_{bb'} C_{b'c}$
Forward current (DC or average value)	I_F
Forward current, maximum (peak value)	i_{FM}
Forward, short-circuit, current transfer ratio, dynamic, in common emitter circuit	α
Forward, short-circuit, current transfer ratio, dynamic, in common base circuit, at $f = 1$ kHz	α_0
Forward, short-circuit, current transfer ratio, dynamic, in common collector circuit	γ
Forward, short-circuit, current transfer ratio, dynamic, in common emitter circuit	β
Forward, short-circuit, current transfer ratio, dynamic, in common emitter circuit at $f = 1$ kHz	$h_{fe} = \beta_0$
Forward current transfer ratio, static, in common base circuit	A
Forward current transfer ratio, static, in common emitter circuit	$h_{FE} = B$
Forward current transfer ratio with short-circuited output	h_{21}
Forward recovery time	t_{fr}
Forward transconductance, capacitance of (of parameter y_{21})	C_{21}
Forward transconductance, imaginary component of (of parameter y_{21})	b_{21}
Forward transconductance, phase angle of (of parameter y_{21})	ϕ_{21}
Forward transconductance, real component of (of parameter y_{21})	g_{21}
Forward transconductance with short-circuited output	Y_{21}
Forward voltage	V_F
Forward voltage, maximum (peak value)	V_{FM}
Frequency	f
Frequency for $\beta = 1$	f_{β_1}
Generator, internal admittance of	G_g
Generator, internal resistance of	R_g

Hybrid matrix, parameter of	h
Imaginary component of the short-circuit forward transconductance (of parameter y_{21})	b_{21}
Imaginary component of the short-circuit input admittance (of parameter y_{11})	b_{11}
Imaginary component of the short-circuit output admittance (of parameter y_{22})	b_{22}
Imaginary component of the short-circuit reverse transconductance (of parameter y_{12})	b_{12}
Imaginary component of the y -parameters	b
Input AC (in general)	i_1
Input AC voltage (in general)	v_1
Input admittance, capacitance of (of parameter y_{11})	C_{11}
Input admittance, imaginary component of (of parameter y_{11})	b_{11}
Input admittance, phase angle of (of parameter y_{11})	φ_{11}
Input admittance, real component of (of parameter y_{11})	g_{11}
Input admittance with short-circuited output	y_{11}
Input impedance (in general)	Z_1
Input impedance with short-circuited output	h_{11}
Input radio frequency voltage	v_{RF}
Integration time	t_{av}
Junction capacitance of diodes	C_j
Junction contact potential	V_R
Junction temperature	T_j
Load admittance	G_L
Load capacitance	C_L
Load resistance	R_L
Loss resistance	R_d
Maximum, in a subscript (peak value)	M, m
Maximum, in a subscript (e. g. upper limit of spread)	\max
Maximum forward current (peak value)	i_{FM}
Maximum oscillation frequency	f_{\max}
Maximum permissible forward current (peak value)	\dot{i}_{FM}
Maximum reverse voltage (peak value)	v_{RM}
Maximum value of tunnel current	I_1
Minimum, in a subscript (e. g. lower limit of spread)	\min
Mixing noise figure	NF_c
Neutralization capacitance	C_N
Noise factor	NF
Noise figure, mixing	NF_c
Open-circuit output admittance	h_{22}
Open-circuit voltage	v_L
Open-circuit voltage feedback	h_{12}
Optimum load resistance	R_{LL}
Operating frequency	f
Output AC current (in general)	i_2
Output AC voltage (in general)	v_2
Output voltage, effective	V_{Oeff}

Output admittance, capacitance of (of parameter y_{22})	C_{22}
Output admittance, imaginary component of (of parameter y_{22})	b_{22}
Output admittance, phase angle of (of parameter y_{22})	φ_{22}
Output admittance, real component of (of parameter y_{22})	g_{22}
Output admittance with open input	h_{22}
Output admittance with short-circuited input	y_{22}
Output impedance (in general)	Z_2
Output voltage (measured peak-to-peak)	$V_a (V_A)$
Overdriving factor	\ddot{u}
Parallel capacitance	C_p
Peak-to-peak voltage	V_{pp}
Phase-angle of the short-circuit input admittance (of parameter y_{11})	φ_{11}
Phase-angle of the short-circuit forward transconductance (of parameter y_{21})	φ_{21}
Phase-angle of the short-circuit output admittance (of parameter y_{22})	φ_{22}
Phase-angle of the short-circuit reverse transconductance (of parameter y_{12})	φ_{12}
Power, maximum available	P_{OM}
Power dissipation	$P; p$
Power dissipation, total	P_{tot}
Power gain	G_p
Power gain in common base circuit	G_{pb}
Power gain in common base circuit, optimum	$G_{pb \text{ opt}}$
Power gain in common emitter circuit	G_{pe}
Power gain in common emitter circuit, optimum	$G_{pe \text{ opt}}$
Pulse length	t
Quality factor	Q
Real component of the forward transconductance (of parameter y_{21})	g_{21}
Real component of the short-circuit input admittance (of parameter y_{11})	g_{11}
Real component of the short-circuit output admittance (of parameter y_{22})	g_{22}
Real component of the short-circuit reverse transconductance (of parameter y_{12})	g_{12}
Real component of the y -parameters	g
Recording current (DC or average value)	I_A
Recording current, maximum (peak value)	i_{AM}
Recording winding, inductance of	L_A
Recording winding, DC resistance of	R_A
Rectified current	I_o
Rectified voltage	V_o
Reference temperature	T_o
Resistance (DC value)	R
Resistance (instantaneous value)	r
Resistance, negative, amount of	R_n
Resistivity, temperature coefficient of	α
Reverse current	I_R
Reverse delay time (Transistors)	t_{rr}
Reverse impedance with input open	Z_{12}
Reverse power loss	$G_{pb \text{ inv}}$
Reverse recovery time (Diodes)	t_{rr}
Reverse transconductance, capacitance of (of parameter y_{12})	C_{12}
Reverse transconductance, imaginary component of (of parameter y_{12})	b_{12}
Reverse transconductance, phase angle of (of parameter y_{12})	φ_{12}
Reverse transconductance, real component of (of parameter y_{12})	g_{12}

Reverse transconductance with short-circuited input	y_{12}
Reverse voltage	V_R
Reverse voltage – anode to cathode	V_{DD}
Reverse voltage – cathode to cathode gate	V_{GR}
Reverse voltage, maximum permissible (peak value)	V_{RM}
Reverse voltage transfer ratio, open-circuit	h_{12}
Rise time	t_r
Series inductance	L_S
Series resistance	R_S
Slope angle of the linearized and normalized Hall-effect device characteristic	φ
Short-circuit forward current transfer ratio	h_{21}
Short-circuit forward current transfer ratio, dynamic, in common base circuit	α
Short-circuit current gain, dynamic, in common base circuit at $f = 1$ kHz	α_0
Short-circuit current gain, dynamic, in common collector circuit	γ
Short-circuit current gain, dynamic, in common emitter circuit	β
Short-circuit current gain, dynamic, in common emitter circuit at $f = 1$ kHz	$\beta_0 = h_{ie}$
Short-circuit input admittance	Y_{11}
Short-circuit input admittance, phase angle of (of parameter y_{11})	φ_{11}
Short-circuit input impedance	h_{11}
Short-circuit output admittance	Y_{22}
Short-circuit output admittance, phase angle of (of parameter y_{22})	φ_{22}
Short-circuit forward transconductance	Y_{21}
Short-circuit forward transconductance, phase angle of (of parameter y_{21})	φ_{21}
Short-circuit reverse transconductance	Y_{12}
Short-circuit reverse transconductance, phase angle of (of parameter y_{12})	φ_{12}
Standardized capacitance	C_n
Storage temperature	T_S
Storage time	t_s
Storage time constant	τ_s
Switching time constant	τ
Switch-off time	t_{off}
Switch-off voltage	V_{AKS}
Temperature	T
Temperature coefficient (temperature-dependent)	$TC; \alpha_T$
Temperature coefficient of resistivity	α
Temperature difference	ΔT
Test current, permissible, for self-heating by $\Delta T = 1$ °C as referred to static ambient air	$I_{Me\theta}$
Test voltage, permissible, for thermistors to achieve self-heating by $\Delta T = 1$ °C as compared with static ambient air	$V_{Me\theta}$
Thermal (in a subscript)	th
Thermal capacity. This is the energy to be fed to, say, a thermistor in order to heat by 1 °C (irrespective of heat dissipation to the environment)	C_{th}
Thermal resistance	R_{th}
Thermal resistance of a chassis (cooling plate not heat sink)	R_{thc}
Thermal resistance, rated value in operating condition	R_W
Thermal resistance between junction (heat source) and case with infinitely good heat dissipation from the case ($T_{case} = T_{amb}$)	$R_{thJcase}$
Thermal resistance between junction (heat source) and static ambient air	R_{thJamb}
Thermal resistance between junction (heat source) and static ambient air when using a cooling plate of defined size	R_{thL}

Time	t
Time constant	τ
Total diode capacitance	C_D
Total dissipation	P_{tot}
Transconductance, internal	g_m
Transistor	T_r
Transit frequency (extrapolated cutoff frequency for $\beta = 1$; $f_{\beta T} \approx f_1$)	f_T
Tunnel current, maximum value of	I_1
Tunnel current, minimum value of	I_2
Turn-off base current	I_{B2}
Turn-off base current factor	a
Turn-on time ($t_{on} = t_d + t_r$)	t_{on}
Voltage	V, v
Voltage at maximum tunnel current	V_1
Voltage at minimum tunnel current	V_2
y-paramter, capacitance of	C
y-parameter, imaginary component of	b
y-parameter, phase angle of	φ
y-parameter, real component of	g

2.3.4. Explanations of the Symbols and Terms Used

This section contains brief explanations of the symbols and terms used in the data sheets for transistors.

In order to distinguish between the different voltages and currents of the transistor, suffix letters are used.

The letters provide information on the type of connection of the transistor terminals. The order in which they are indicated together with the sign (+ or -) indicates the direction of the voltage or current. The technical concept of current flow applies (current flow from + to -).

The three transistor terminals are denoted as follows:

Emitter	E
Base	B
Collector	C, K

In order to characterize the cutoff currents and reverse voltages, a third suffix letter is used. This letter provides information on the type of connection of the third terminal which is not otherwise mentioned.

The following abbreviations are used:

- O The third unmentioned terminal is open.
- R Ohmic resistance between the terminal mentioned in the second place and the third terminal.
- S Short circuit between the terminal mentioned in the second place and the third terminal.
- V Reverse bias voltage between the terminal mentioned in the second place and the third terminal.

2.3.5. Explanation of important electrical parameters

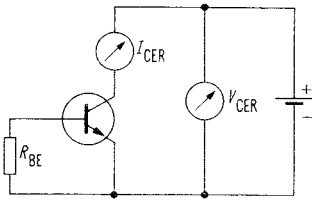

V_{CER} (I_{CER})
 Collector-emitter reverse voltage (collector-emitter cutoff current) with a resistor between base and emitter. The maximum permissible resistance value R_{BE} is stated in the data sheets. For higher values of R_{BE} the reverse voltage V_{CEO} applies

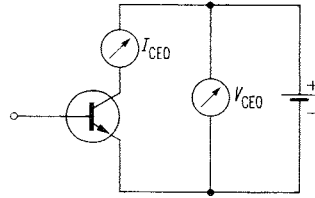

V_{CEO} (I_{CEO})
 Collector-emitter reverse voltage (collector-emitter cutoff current) with base open: $I_B = 0$. The state $I_B = 0$ may also occur for a short while, e. g. in operation as a switch, with a resistance interposed between base and emitter.

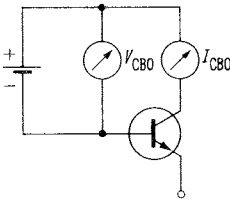

V_{CBO} (I_{CBO})
 Collector-base reverse voltage (collector-base cutoff current) with emitter open: $I_E = 0$

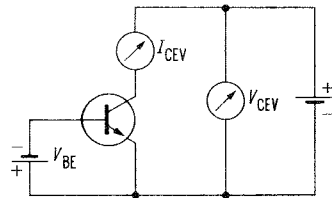

V_{CEV} (I_{CEV})
 Collector-emitter reverse voltage (collector-emitter cutoff current) with blocked emitter diode, i. e., base positive referred to the emitter

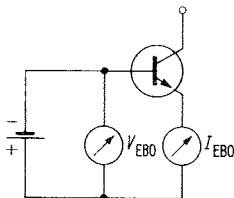

V_{EBO} (I_{EBO})
 Emitter base reverse voltage (emitter-base cutoff current) with collector open: $I_C = 0$

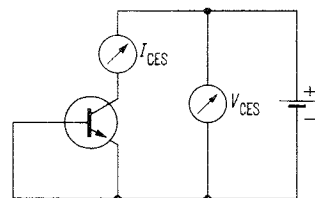

V_{CES} (I_{CES})
 Collector-emitter reverse voltage (collector-emitter cutoff current) with shorted emitter diode: $V_{BE} = 0$

2.4. Mounting and Soldering Instructions for Semiconductor Components

Transistors and diodes may be mounted in any position. With all semiconductor components, bending of the leads is permitted if the minimum clearance between bend and case bottom is 1.5 mm and if the diameter of the leads does not exceed 0.6 mm. In case the diameters exceed this value the terminal leads should not be bent.

Each semiconductor component is highly sensitive to exceeding the maximum permissible junction temperature. In equipment design, care should therefore be taken in choosing a sufficiently large clearance between heat source and component.

When making solder connections for semiconductor components, care should be taken to ensure that the component is not thermally overloaded. During the soldering process the junction temperature must not exceed 110 °C for germanium components and 200 °C for silicon components. (Maximum soldering time 1 minute.)

During the soldering operation, high mechanical stress on the leads should be avoided.

Soldering data

Lead length L	0 ¹⁾	1.5	5	mm ²⁾
Soldering temperature 245 °C	4	5	10	s
Soldering temperature 300 °C	2.5	3	5	s

- 1) L=0 is permissible only for transistors and diodes in special T-cases (plastic) and SOD-23 cases or similar strip-line designs if the case does not get into contact with the soldering iron. The leads of these components may be bent directly at the case using a radius of 0.5 mm (natural bending radius as will be encountered when bending manually without exerting any tensile force on the leads).
- 2) The lead length is measured as the distance between case and soldering point, i.e. for standard clad boards as from the board bottom and for through-plated holes as from the board top.

Mounting Instructions for Semiconductor Components in Plastic Cases

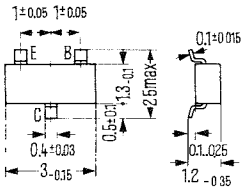

Please write for special soldering instructions for semiconductor components in the SOT-23 plastic case

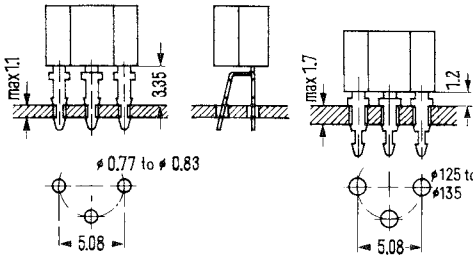

Soldering temperature in dip soldering
 $T_L = 245\text{ }^\circ\text{C}$
 max. soldering time 4 sec

Plastic case (SOT-25)
 11A3 DIN 41869 B13

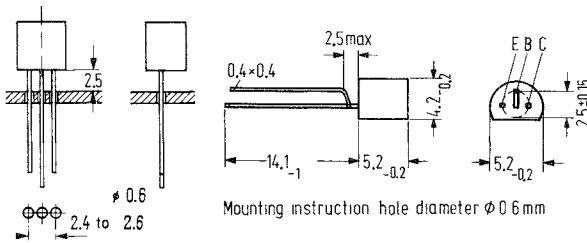

Minimum connecting length of wires 2.5 mm
 also see Mounting Instructions

Plastic case TO-92 and
 10A3 DIN 41868 (TO-92)

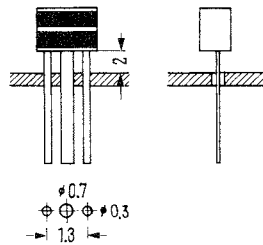

Minimum connecting length of wires 2 mm

Miniature plastic (U 32)

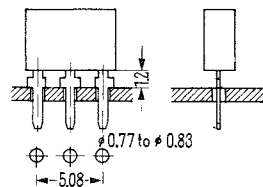

Plastic diode case
 (e. g. SOD-37)

Dimensions in mm

Mounting and Soldering Instructions for Transistors in a Plastic Case, Especially for Types 12 A 3 DIN 41 868 (SOT-32) and 10 A 3 DIN 41 869 (SOT-30), Formerly TO-92 (Band-Lead Design).

Mounting of SOT-32 cases should be carried out by means of a M 3 screw with a torque of 5 cm/kp (min.) to 8 cm/kp (max.) (corresponding to 50 to 80 cm N). A washer or rather a lockwasher A 3 DIN 137 should be used. (Order number Q 62902-B 63). Mounting holes of larger than 3.5 dia. are to be avoided as well as axial forces upon terminal wire during the mounting operation.

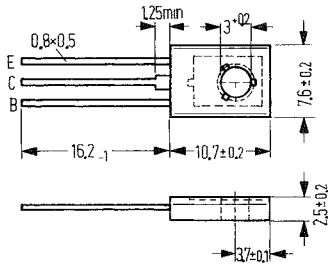

Case 12 A 3 DIN 41869 (SOT-32)

Insulation of SOT-32 cases is feasible by means of a mica disc, 50 μ thick (order number Q 62902-B 62).

The thermal resistance is increased by a dry disc by 8 K/W and by a disc greased with special mounting paste by 4 K/W.

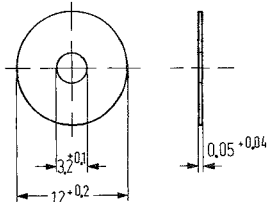

Mica disc
Q62902-B62

Mounting Hints

The leads of SOT-32 and SOT-30 cases can absorb only small axial forces. Forces acting in this direction and exceeding 1.5 kp might result in the permanent destruction of the component. The little flexible leads should thus not be bent or twisted to excess. It is recommended to use a bending device or long-nose pliers, with the pliers held between case and bending point in order to stabilize the terminal strips. Tensions on the case are thus avoided.

The following points should be observed when bending the terminal strips:

1. Strips should be held tightly between bending point and plastic case in order to avoid mechanical tensions between case and connecting point.
2. When bending the leads vertically to the mounting plane, a minimum clearance of 1 mm must be observed. Bending radius not below 1.6 mm.
3. Bending in the mounting plane should be carried out with a minimum clearance from the case of 3 mm and a minimum bending radius of 4 mm.
4. Avoid repeated bendings since the bending capacity is limited to three bendings (90°).
5. Do not bend leads directly at the case.

The soldering time is 5 s max. at 245 °C and 2 mm clearance from the case.

2.5. Transistors

2.5.1. Basic Transistor Circuits

Common emitter

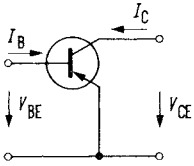

Common base

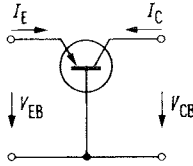

Common collector

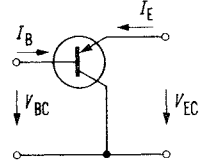

Characteristics of the Transistor Basic Circuits

	Common emitter	Common base	Common collector
Input impedance	medium	low	high
Z_1	Z_{1e}	$Z_{1b} \approx \frac{Z_{1e}}{\beta}$	$Z_{1c} \approx \beta \cdot R_L$
Output impedance	high	very high	low
Z_2	Z_{2e}	$Z_{2b} \approx Z_{2e} \cdot \beta$	$Z_{2c} \approx \frac{Z_{1e} + R_g}{\beta}$
Small-signal value of the short-circuit forward current transfer ratio	high β	< 1 $\alpha \approx \frac{\beta}{\beta + 1}$	high $\gamma \approx \beta + 1$
Voltage gain	high	high	< 1
Power gain	very high	high	medium
Cutoff frequency	low f_β	high $f_\alpha \sim \beta \cdot f_\beta$	low $\approx f_\beta$

2.5.2. Permissible Total Power Dissipation P_{tot} of Transistors

The permissible total power dissipation of power transistors as a function of the ambient temperature T_{amb} , with the voltage V_{CE} as parameter, is stated in a family of curves. These curves are based on uniform reliability.

According to these curves, the permissible total power dissipation decreases with increasing collector voltage.

The following curves have to be considered as examples.

At load operation the heat in the chip of the semiconductor component is not equally distributed, but dependent on the current and the applied voltage. At higher collector voltages, the cross section in the semiconductor leading the current flow changes with increasing temperature gradient in the chip, so that the thermal resistance increases.

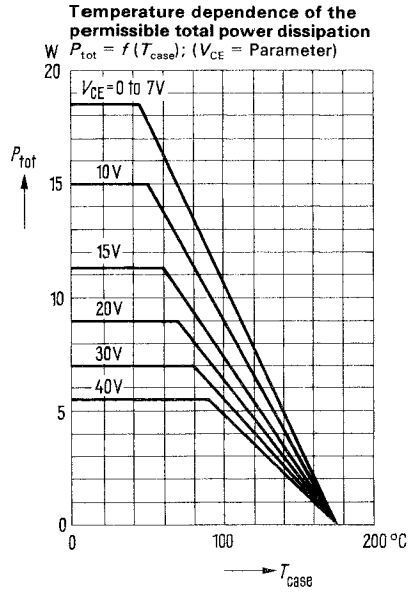

Current and voltage dependence of the thermal resistance $R_{thJC} = f(V_{CB})$
 ($I_C = \text{Parameter}$)

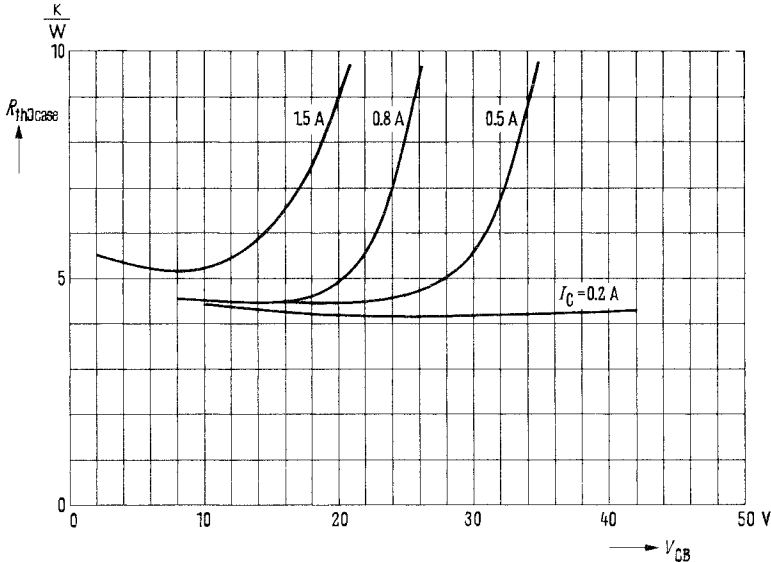

If this characteristic, dependent on the structure and size of the semiconductor component, is not observed, a strong pinchoff effect sets in. Thus at relatively low powers compared to the maximum permissible power dissipation the chip is heated to such an extent that it melts in certain areas, i. e. the transistor can be destroyed. The heat capacitance of such a current channel is extremely low, so that time constants of, e. g., 10^{-7} sec. occur in spite of the high thermal resistance. The reverse voltage breaks down due to the suddenly existing high temperature. Thus, this effect is called "second breakdown".

With transistors loads can be switched, the powers of which are higher than the static power dissipation. Usually the power dissipation valid for continuous load will be exceeded during a switching process. This is allowable, if the heat capacitance of the chip and the heat dissipation prevent the losses occurring for a short time from heating the transistor chip beyond the maximum permissible junction temperature.

Diagrams are given to compute the maximum junction temperature occurring. The demonstration of such diagrams is particularly necessary for power transistors by mounting on heat sinks.

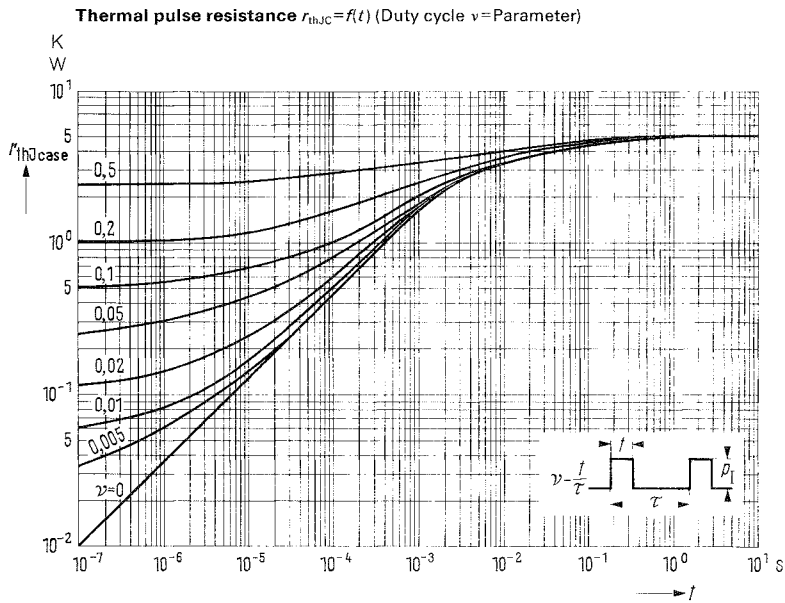

The diagram below has been derived from the thermal transient process of a transistor. The equivalent circuit of the thermal resistance R_{th} can be demonstrated as a line with distributed R and C sections. Due to the existing heat capacities transistors are able to withstand pulse powers greater than the static permissible total power dissipation. (Compare DIN 41862)

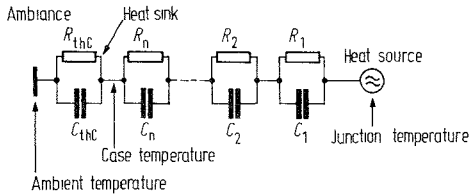

If the transistor is operated near the maximum permissible junction temperature two diagrams have to be considered for the computation of the maximum junction temperature. The diagram for the thermal resistance vs. time is valid without reservation for operation at voltages with a limited secondary breakdown. The voltage dependence of the thermal resistance has to be considered however for the voltage range without a secondary breakdown. In this case the thermal resistance $r_{thJC} = f(f)$ has to be multiplied by a voltage dependent correction factor K_V . This factor is determined from the diagram $P_{tot} = f(T_{case})$ as the ratio P_{tot} to P_V . P_{tot} is the maximum total permissible power dissipation; P_V is the maximum permissible pulse dissipation at the operation voltage V_{CE} . The voltage dependent correction factor can also be calculated in a similar way for static load.

$$R_{thJC(V)} = K_V R_{thJC} = \frac{P_{tot}}{P_V} R_{thJC}$$

$$r_{thJC(V)} = K_V \cdot r_{thJC} = \frac{P_{tot}}{P_V} \cdot r_{thJC}$$

The diagram "Permissible pulse load" permits calculation of the maximum permissible pulse dissipation P_1 .

First, a factor " m " is read from the diagram for the duty cycle " ν " and the pulse length " t " given in that particular application and then " P_V " is determined using the diagram "Maximum total power dissipation as a function of temperature" at the operating voltage.

The maximum permissible pulse dissipation is thus derived from the equation $P_1 = m \times P_V$

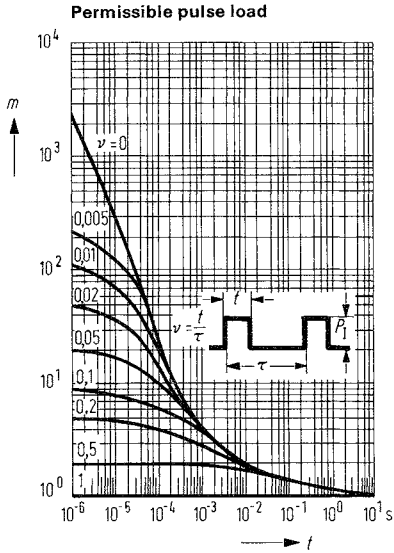

If the pulse shape is not rectangular the full pulse magnitude has to be considered and for the pulse duration an approximation has to be made, which results from the pulse width at 20% of the total pulse magnitude. A conversion into a square is not permissible due to the complex thermal resistance.

The maximum of the junction temperature may then be calculated according to the equation:

$$T_j = (P_o + \nu P_1) \underbrace{(R_{thJamb} - K_V R_{thJcase})}_{R_{thC}} + P_o K_V R_{thJcase} + P_1 K_V \cdot r_{thJcase} + T_{amb}$$

If the maximum permissible junction temperature is exceeded the calculation has to be repeated with a larger heat sink.

The single contributions to increase the junction temperature may be derived from the following example.

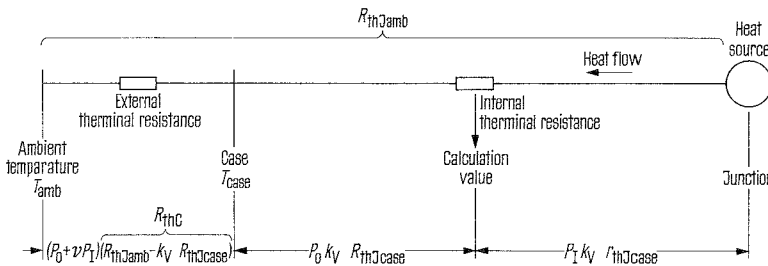

Meanings of the used symbols:

- P_1 Peak value of the power dissipation (pulse dissipation)
- P_o Dissipation averaged over one cycle
- t Duration of the pulse dissipation
- ν Duty cycle $\frac{t}{\tau}$
- τ Impulse period
- νP_1 Arithmetic mean of the pulse dissipation during a cycle
- r_{thJC} Thermal pulse resistance
- K_V Voltage dependent correction factor
- P_V Maximum permissible total power dissipation at V_{CE}
- R_{thC} Thermal resistance between case and ambient temperature

Power dissipation of a transistor used as switch:

Output pulse

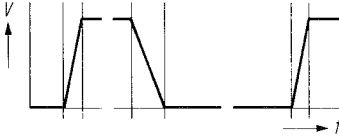

During a switching period losses occur in a transistor due to reverse, turn on, forward and turn-off dissipation. The following illustrations show the power dissipation occurring in a transistor used as switch with an inductive, resistive and capacitive load.

Transistor Power Dissipation

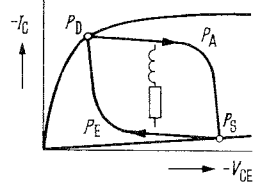
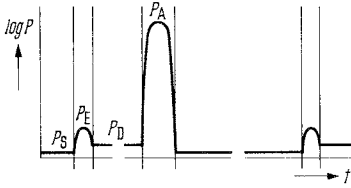

Inductive Load

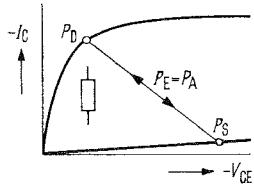
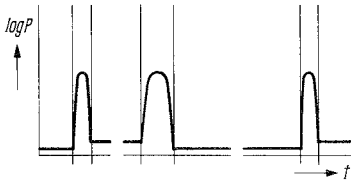

Resistive Load

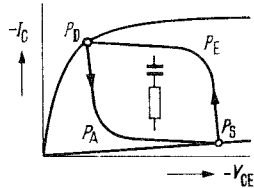
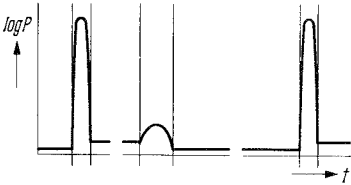

Capacitive Load

Instead of a wave-type curve a rectangular pulse form may be assumed. In case of a resistive or predominantly resistive load the simplifying assumption can be made that the turn-on pulse is immediately followed by the turn-off pulse. Under these conditions the following deductions may be made.

Load	Pulse length t	Pulse dissipation	Dissipation averaged over one cycle
L	t_{off}	P_A	$P_S + P_E + P_D$
R	$t_{\text{on}} + t_{\text{off}}$	$P_E = P_A$	$P_S + P_D$
C	t_{on}	P_E	$P_S + P_D + P_A$

- P_S Reverse losses
- P_E Peak value of the turn-on losses
- P_D Forward losses
- P_A Peak value of the turn-off losses

2.5.3. Permissible Operating Range

For many transistor types the permissible operating range in the I_C vs. V_{CE} set of characteristics (SOAR curves) is given in accordance with the graph shown below. Within this range, any combination of I_C and V_{CE} is permitted.

Care must be taken that the dwell time stated in the family of characteristics is not exceeded.

The family of characteristics shown cover both the voltage dependence ($P_{tot} = f(T_{case})$) and the current dependence. Moreover, the recurrence frequency of the maximum permissible load is stated.

Irregularities in the family of characteristics are based on the maximum ratings, such as maximum junction temperature, current-carrying capacity and influence of the voltage dependence (secondary breakdown).

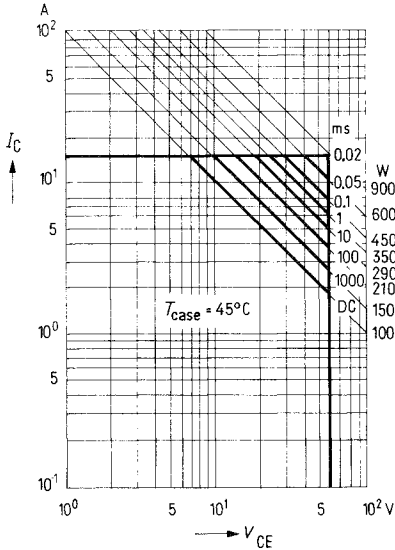

2.5.4. Heat Dissipation of Transistors

For power transistors mounted on a chassis plate for better heat dissipation the symbol $R_{th\text{Jamb}}$ for the thermal resistivity (preceding section) is replaced by the symbol R_{thL} .

$$R_{thC} = R_{thL} - R_{th\text{ case}}$$

The thermal resistance of the chassis, R_{thC} , is calculated with the aid of the following approximation formula (it applies only for cooling plates – not for cooling fins):

$$R_{thC} = \frac{3.3}{\sqrt{\lambda \cdot d}} C^{0.25} + \frac{650}{A} C$$

λ : coefficient of thermal conductivity for the chassis plate, in W/K cm

Material	λ (W/K cm)
Aluminium	2.1
Copper	3.8
Brass	1.1
Steel	0.46

d Thickness of chassis, in mm

A Surface of chassis, in cm²

C Correction factor for position and surface characteristics of the chassis plate

Surface \ Position	Bare	Black
Vertical	0.85	0.43
Horizontal	1	0.5

The formula applies to chassis plates not deviating too much from the square form and with the transistor mounted in the center of it constituting the only source of heat. The values of the constants λ and C apply in static air up to an ambient temperature of approximately 45 °C, provided there are no heat-radiating parts nearby.

Heat-transfer resistance of a mica disc R_{th} (K/W)

Case	Disc thickness, dry		Disc greased on both sides will reduce resistance by:
	50 μ	100 μ	
TO-3	1.25	1.5	0.9 K/W
TO-41 sim.	1.25	1.5	0.9 K/W
SOT-9	2.5	3.0	1.5 K/W
SOT-32	8.0	10.0	4.0 K/W

2.5.5. Switching Times of Transistors

If transistors are used as switches, the output pulse is distorted and delayed compared with the input pulse.

The following diagram shows the switching behaviour of a transistor in a common emitter circuit.

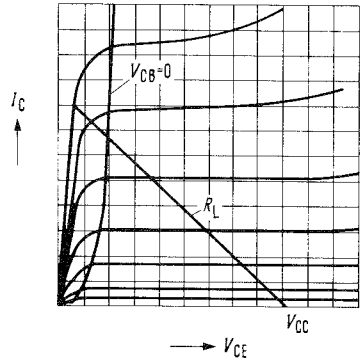
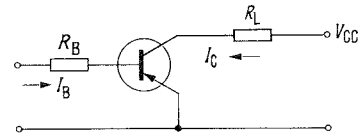
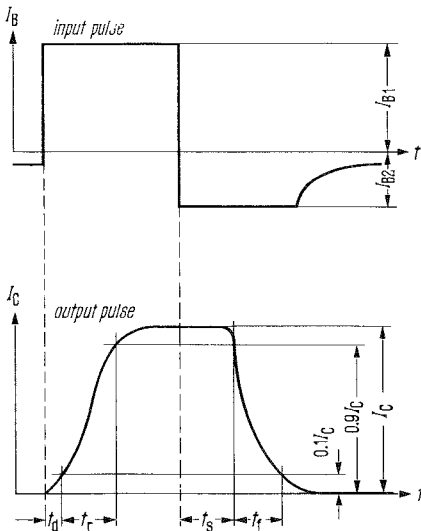

With the aid of the above illustration, the following times can be defined:

Switch-on Time; $t_{on} = t_d + t_r$

The switch-on time is the time required by the output current (collector current) to rise to 90% of its maximum value after the control current (base current) has been applied. It is composed of the delay time t_d and the rise time t_r .

The delay time is the time required by the collector current to rise to 10% of its final value after the control pulse has been applied. The rise time is the time required by the collector current to rise from 10% to 90% of its final value.

Switch-off Time; $t_{off} = t_s + t_f$

The switch-off time is the time required by the output current to drop to 10% of its maximum value after completion of the control pulse.

It is composed of the storage time t_s and the fall time t_f .

The storage time is the time required by the output current (collector current) to drop to 90% of its maximum value after the control current (base current) has been removed. The fall time is the time required by the output current (collector current) to drop from 90% to 10% of its maximum value.

The shortest switching times may be realized in common base circuit because of the high control currents while the switch-off time of collector stages is particularly low because of insufficient saturation.

The following switching times apply to saturated operation in common emitter circuit, where:

$I_{B0} =$ the base current driving the transistor up to the overdriving limit

$I_{B1} > I_{B0}$ the switch-on base current

$I_{B2} \approx I_{B0}$ the switch-off base current

a) Delay time t_d

After application of a control signal the time t_d will elapse before the emitter-base junction capacitance C_{EB} is reversed and the emitter diode is poled in forward direction. t_d becomes shorter with increasing control current $I_{B1} \cdot t_d \ll t_r$ is quite frequent with power transistors.

b) Rise time t_r

During t_r the controlling charge must be build up at the base through the control current. By definition

$$t_r = \tau_C \ln \frac{I_{B1}/I_{B0} - 0.1}{I_{B2}/I_{B0} - 0.9}$$

The component factor τ_C (time constant with current control) is of the order of the carrier life, i. d. typically 1 to 10 μ for power transistors and 1 to 2 orders smaller for high-speed switches. The test condition factor shows that t_r becomes very small with high control currents $I_{B1} \gg I_{B0}$. Because of its dependence on the forward current transfer ratio t_r rises with increasing I_C .

c) Storage time t_s

After reaching the overdriving limit the base current portion $I_{B1} > I_{B0}$ is used to build up a saturation storage charge. When switching off, this storage charge first has to be reduced during t_s before I_C may fall. Then:

$$t_s = \tau_s \ln \frac{I_{B2}/I_{B0} + I_{B1}/I_{B0}}{I_{B2}/I_{B0} + 1} + t(90\% I_C)$$

The second term defining the decrease of I_C to 90 % may generally be neglected considering the first expression. The storage time constant τ_s may also be compared with the carrier life, s.b). The test condition factor reveals that a short storage time may be realized with a small I_{B1} but a high switch-off base current I_{B2} . In accordance with the decline in the forward current transfer ratio h_{FE} – and increase of I_{BC} – the storage time decreases towards high collector currents.

d) Fall time t_f

During the fall time the base control charge theoretically declines together with I_C in accordance with the following relation:

$$t_f = \tau_s \ln \frac{I_{B2}/I_{B0} + 0.9}{I_{B2}/I_{B0} + 0.1}$$

This equation predicting a decline of t_f with a higher switch-off current in practice only applies to transistors without a collector storage charge, i. e. for epibase and single-

diffused transistors or for planar transistors with a low V_{CB0} value. With highly reversing triple-diffused types t_{fr} however, is influenced by the way in which the collector residual charge can be removed from the transistor via the base. In practice this often leads to an increase of t_f with I_{B2} and I_C . An increase with I_{B1} , which is not expressed by the above equation, is also frequently noted. For high-speed, highly reversing power switches the switching-time data may easily be stated and checked with the aid of the following measuring circuit diagram:

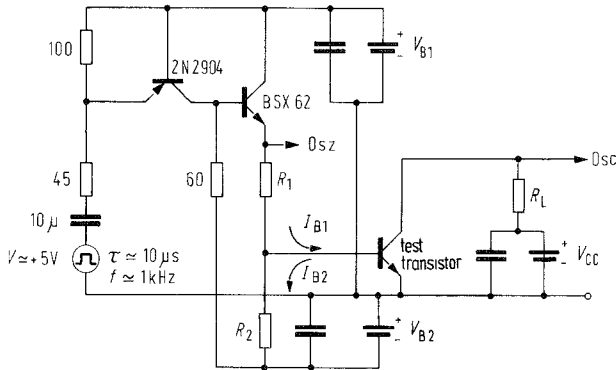

The driving circuit shown is adequate when there is no pulse generator for a few amperes of control current. The following relation applies between the desired currents and the corresponding resistance values:

$$R_1 \cong \frac{V_{B1} - V_{BEsat}}{|I_{B1} + I_{B2}|} \quad (V_{BEsat} \text{ of type BSX 62} \cong 0 \text{ V})$$

$$R_2 = \frac{|V_{B2}| + V_{BEsat}}{|I_{B2}|}$$

$$R_L = \frac{V_{CC} - V_{CEsat}}{I_C}$$

The following voltage values are recommended for use with triple diffused transistors:

$$\begin{aligned} V_{CC} &= 60 \text{ V} & |V_{B2}| &= 5 \text{ V} \\ V_{B1} &= 11 \text{ V} \end{aligned}$$

$V_{BEsat} \cong 1 \text{ V}$, $V_{CEsat} \cong 0 \text{ V}$ may be approximately assumed for the transistors tested.

2.5.6. The Transistor as a Linear Four-Terminal Network

Description of the Transistor by h -Parameters in the AF Range.

The hybrid or h -parameters, as a rule, are stated as real values.

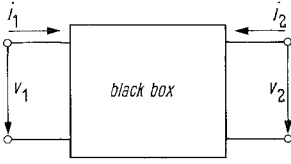

$$v_1 = h_{11} \cdot i_1 + h_{12} \cdot v_2$$

$$i_2 = h_{21} \cdot i_1 + h_{22} \cdot v_2$$

The parameters have the following meanings:

$$h_{11} = \frac{v_1}{i_1} \text{ at } v_2 = 0$$

Small-signal value of the short-circuit input impedance (Ω)

$$h_{12} = \frac{v_1}{v_2} \text{ at } i_1 = 0$$

Small-signal value of the open-circuit reverse voltage transfer ratio

$$h_{21} = \frac{i_2}{i_1} \text{ at } v_2 = 0$$

Small-signal value of the short-circuit forward current transfer ratio

$$h_{22} = \frac{i_2}{v_2} \text{ at } i_1 = 0$$

Small-signal value of the open-circuit output admittance (milli-mhos)

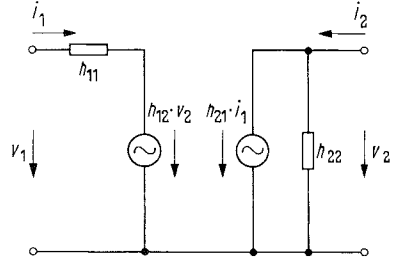

Relations between the h -Parameters in Common Base and Common Emitter Circuits

$$\begin{pmatrix} h_{11b} & h_{12b} \\ h_{21b} & h_{22b} \end{pmatrix} = \frac{1}{1 + h_{21e} - h_{12e} + \Delta h_e} \begin{pmatrix} h_{11e} & - (h_{12e} - \Delta h_e) \\ - (h_{21e} + \Delta h_e) & h_{22e} \end{pmatrix}$$

$$\begin{pmatrix} h_{11b} & h_{12b} \\ h_{21b} & h_{22b} \end{pmatrix} \approx \frac{1}{1 + h_{21e}} \begin{pmatrix} h_{11e} - (h_{12e} - \Delta h_e) \\ - h_{21e} & h_{22e} \end{pmatrix}$$

$$\begin{pmatrix} h_{11e} & h_{12e} \\ h_{21e} & h_{22e} \end{pmatrix} = \frac{1}{1 + h_{21b} - h_{12b} + \Delta h_b} \begin{pmatrix} h_{11b} & - (h_{12b} - \Delta h_b) \\ - (h_{21b} + \Delta h_b) & h_{22b} \end{pmatrix}$$

$$\begin{pmatrix} h_{11e} & h_{12e} \\ h_{21e} & h_{22e} \end{pmatrix} \approx \frac{1}{1 + h_{21b}} \begin{pmatrix} h_{11b} - (h_{12b} - \Delta h_b) \\ - h_{21b} & h_{22b} \end{pmatrix}$$

$$\Delta h = h_{11} \cdot h_{22} - h_{12} \cdot h_{21}$$

Description of the Transistor by y -Parameters in the RF Range.

The admittance or y -parameters, as a rule, are stated as real values.

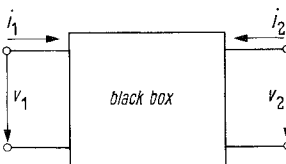

$$i_1 = y_{11} \cdot v_1 + y_{12} \cdot v_2$$

$$i_2 = y_{21} \cdot v_1 + y_{22} \cdot v_2$$

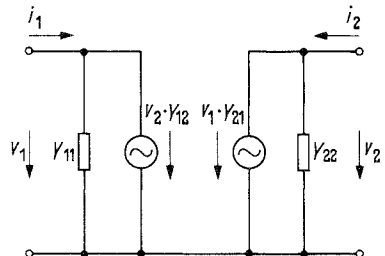

$$y_{11} = g_{11} + jb_{11} = \left(\frac{i_1}{v_1} \right)_{v_2=0}$$

Small-signal short-circuit
input admittance (mmhos)

$$y_{12} = g_{12} + jb_{12} = \left(\frac{i_1}{v_1} \right)_{v_1=0}$$

Small-signal short-circuit
reverse transfer admittance

$$y_{21} = g_{21} + jb_{22} = \left(\frac{i_2}{v_1} \right)_{v_2=0}$$

Small-signal short-circuit
forward transfer admittance (mA/V)

$$y_{22} = g_{22} + jb_{22} = \left(\frac{i_2}{v_2} \right)_{v_1=0}$$

Small-signal short-circuit
output admittance (mmhos)

Relations between the y -Parameters in Common Base and Common Emitter Circuits

$$\begin{pmatrix} Y_{11b} & Y_{12b} \\ Y_{21b} & Y_{22b} \end{pmatrix} = \begin{pmatrix} Y_{11e} + Y_{12e} + Y_{21e} + Y_{22e} & -(Y_{12e} + Y_{22e}) \\ -(Y_{21e} + Y_{22e}) & Y_{22e} \end{pmatrix}$$

$$\begin{pmatrix} Y_{11e} & Y_{12e} \\ Y_{21e} & Y_{22e} \end{pmatrix} = \begin{pmatrix} Y_{11b} + Y_{12b} + Y_{21b} + Y_{22b} & -(Y_{12b} + Y_{22b}) \\ -(Y_{21b} + Y_{22b}) & Y_{22b} \end{pmatrix}$$

Directions for Calculations Based on h - or y -Parameters

Relations between the h - and y -Parameters

$$\begin{aligned} h_{11} &= \frac{1}{y_{11}} & y_{11} &= \frac{1}{h_{11}} & h_{21} &= \frac{y_{21}}{y_{11}} & y_{21} &= \frac{h_{21}}{h_{11}} \\ h_{12} &= -\frac{y_{12}}{y_{11}} & y_{12} &= -\frac{h_{12}}{h_{11}} & h_{22} &= \frac{\Delta y}{y_{11}} & y_{22} &= \frac{\Delta h}{h_{11}} \\ \Delta h &= h_{11} \cdot h_{22} - h_{12} \cdot h_{21} = \frac{y_{22}}{y_{11}} & \Delta y &= y_{11} \cdot y_{22} - y_{12} \cdot y_{21} = \frac{h_{22}}{h_{11}} \end{aligned}$$

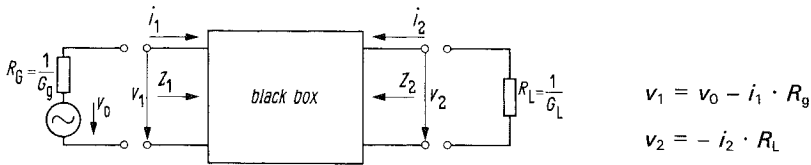

$$v_1 = v_0 - i_1 \cdot R_g$$

$$v_2 = -i_2 \cdot R_L$$

Input impedance $Z_1 = \frac{v_1}{i_1} = \frac{h_{11} + \Delta h \cdot R_L}{1 + h_{22} \cdot R_L} = \frac{1 + y_{22} \cdot R_L}{y_{11} + \Delta y \cdot R_L}$

Output impedance $Z_2 = \frac{v_2}{i_2} = \frac{h_{11} + R_g}{\Delta h + h_{22} \cdot R_g} = \frac{1 + y_{11} \cdot R_g}{y_{22} + \Delta y \cdot R_g}$

Current gain $\frac{i_2}{i_1} = \frac{h_{21}}{1 + h_{22} \cdot R_L} = \frac{y_{21}}{y_{11} + \Delta y \cdot R_L}$

Voltage gain $\frac{v_2}{v_1} = \frac{-h_{21} \cdot R_L}{h_{11} + \Delta h \cdot R_L} = \frac{-y_{21} \cdot R_L}{1 + y_{22} \cdot R_L}$

Transducer gain G_p

$$G_p = \frac{v_2 \cdot i_2}{v_1 \cdot i_1} = \frac{|h_{21}|^2 \cdot R_L}{(1 + h_{22} \cdot R_L)(h_{11} + \Delta h \cdot R_L)} = \frac{|y_{21}|^2 \cdot R_L}{(1 + y_{22} \cdot R_L)(y_{11} + \Delta y \cdot R_L)}$$

Transducer gain, with matched input G_{pmax}

$$G_{pmax} = \frac{4 \cdot h_{21} \cdot R_g \cdot R_L}{[(1 + h_{22} \cdot R_L) \cdot R_g + h_{11} + \Delta h \cdot R_L]^2} = \frac{4 \cdot y_{21} \cdot R_g \cdot R_L}{[(y_{11} + \Delta y \cdot R_L) \cdot R_a + 1 + y_{22} \cdot R_L]^2}$$

Transducer gain, with matched input and output, G_{popt}

$$G_{popt} = \left(\frac{h_{21}}{\sqrt{\Delta h} + \sqrt{h_{11} \cdot h_{22}}} \right)^2 = \left(\frac{y_{21}}{\sqrt{\Delta y} + \sqrt{y_{11} \cdot y_{22}}} \right)^2 \quad \text{with } R_{gopt}, R_{Lopt}$$

$$R_{gopt} = Z_1 = \sqrt{\frac{h_{11}}{h_{22}} \cdot \Delta h} = \sqrt{\frac{y_{22}}{y_{11}} \cdot \frac{1}{\Delta y}} \quad ; \quad R_{Lopt} = Z_2 = \sqrt{\frac{h_{11}}{h_{22}} \cdot \frac{1}{\Delta h}} = \sqrt{\frac{y_{11}}{y_{22}} \cdot \frac{1}{\Delta y}}$$

For $\left[\rho + \frac{\sigma^2}{4} \right] > 1$ there is no matching

ρ = real component of $\frac{Y_{12} Y_{21}}{g_{11} g_{22}}$

σ = imaginary component of $\frac{Y_{12} Y_{21}}{g_{11} g_{22}}$

Description of Transistor by S-Parameters in the RF Range

The S- or scattering parameters are stated as complex quantities with reference to the wave resistance Z_0 of the measuring system.

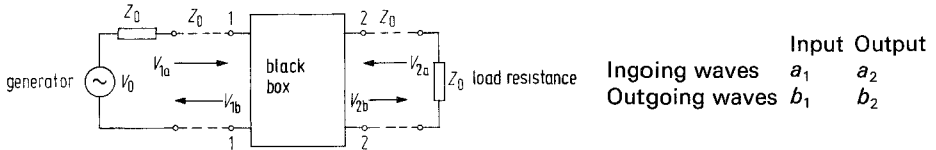

$$b_1 = s_{11} \cdot a_1 + s_{12} \cdot a_2$$

s_{11}, s_{21} are measured at $a_2 = 0$

$$b_2 = s_{21} \cdot a_1 + s_{22} \cdot a_2$$

s_{22}, s_{12} are measured at $a_1 = 0$

by exchanging the generator branch and the load branch.

$$s_{11} = S_{11} e^{j\varphi^{11}} = \left(\frac{b_1}{a_1} \right)_{a_2=0}$$

$$s_{12} = S_{12} e^{j\varphi^{21}} = \left(\frac{b_1}{a_2} \right)_{a_1=0}$$

$$s_{22} = S_{22} e^{j\varphi^{22}} = \left(\frac{b_2}{a_2} \right)_{a_1=0}$$

$$s_{21} = S_{21} e^{j\varphi^{21}} = \left(\frac{b_2}{a_1} \right)_{a_2=0}$$

where: s_{11} = input reflection coefficient
 s_{22} = output reflection coefficient
 s_{21} = forward transfer coefficient
 s_{12} = backward transfer coefficient

Directions for Calculations Based on S-Parameters

Input reflection factor with any termination Z_L
 Γ_0 is the reflection factor of Z_L referred to Z_0

$$s'_{11} = s_{11} + \frac{s_{12} s_{21} \Gamma_L}{1 - s_{22} \Gamma_L}$$

Output reflection factor with any termination Z_G
 Γ_g is the reflection factor of Z_G referred to Z_0

$$s'_{22} = s_{22} + \frac{s_{12} s_{21} \Gamma_G}{1 - s_{11} \Gamma_G}$$

Voltage gain with any termination Z_g and Z_1

$$G_V = \frac{V_2}{V_1} = \frac{s_{21} (1 + \Gamma_L)}{(1 - s_{22} \Gamma_L) (1 + s'_{11})}$$

Stability factor

$$K = \frac{1 + |D|^2 - |s_{11}|^2 - |s_{22}|^2}{2 |s_{12} s_{21}|}$$

Maximum available power gain ($K > 1$)

$$V_{pmax} = \frac{s_{21}}{s_{12}} (K + \sqrt{K^2 - 1}) \quad \text{for positive } B_1$$

$$V_{pmax} = \frac{s_{21}}{s_{12}} (K - \sqrt{K^2 - 1}) \quad \text{for negative } B_1$$

Matching conditions for G_{pmax}

$$\Gamma_G = M^* \left[\frac{B_1 \pm \sqrt{B_1^2 - 4 |M|^2}}{2 |M|^2} \right]$$

$$\Gamma_L = N^* \left[\frac{B_2 \pm \sqrt{B_2^2 - 4 |N|^2}}{2 |N|^2} \right]$$

with $B_1 = 1 + |s_{11}|^2 - |s_{22}|^2 - |D|^2$; $M = s_{11} - D s_{22}^*$;
 $B_2 = 1 + |s_{22}|^2 - |s_{11}|^2 - |D|^2$; $N = s_{22} - D s_{11}^*$;
 $D = s_{11} s_{22} - s_{12} s_{21}$.

Unilateral power gain ($s_{12} = 0$)

$$G_{p0} = G_{p0} G_{p1} G_{p2}; \quad G_{p0} = |s_{21}|^2; \quad G_{p1} = \frac{1 - |\Gamma_g|^2}{|1 - s_{11} \Gamma_g|^2}; \quad G_{p2} = \frac{1 - |\Gamma_L|^2}{|1 - s_{22} \Gamma_L|^2}$$

Optimum power gain ($s_{12} = 0$; matching)

$$G_{popt} = \frac{|s_{21}|^2}{|(1 - |s_{11}|^2)(1 - |s_{22}|^2)|} = G_{p0} G_{p1max} G_{p2max}$$

Matching conditions for G_{popt} : $\Gamma_G = s_{11}^*$ and $\Gamma_L = s_{22}^*$.

Relationship between S-Parameters and y-Parameters

$$\left[\begin{array}{l} s_{11} = \frac{(1 - y'_{11})(1 + y'_{22}) + y'_{12} y'_{21}}{(1 + y'_{11})(1 + y'_{22}) - y'_{12} y'_{21}} \\ s_{12} = \frac{-2 y'_{12}}{(1 + y'_{11})(1 + y'_{22}) - y'_{12} y'_{21}} \\ s_{21} = \frac{-2 y'_{21}}{(1 + y'_{11})(1 + y'_{22}) - y'_{12} y'_{21}} \\ s_{22} = \frac{(1 + y'_{11})(1 - y'_{22}) + y'_{12} y'_{21}}{(1 + y'_{11})(1 + y'_{22}) - y'_{12} y'_{21}} \end{array} \right] \quad \left[\begin{array}{l} y'_{11} = \frac{(1 + s_{22})(1 - s_{11}) + s_{12} s_{21}}{(1 + s_{11})(1 + s_{22}) - s_{12} s_{21}} \\ y'_{12} = \frac{-2 s_{12}}{(1 + s_{11})(1 + s_{22}) - s_{12} s_{21}} \\ y'_{21} = \frac{-2 s_{21}}{(1 + s_{11})(1 + s_{22}) - s_{12} s_{21}} \\ y'_{22} = \frac{(1 + s_{11})(1 - s_{22}) + s_{12} s_{21}}{(1 + s_{22})(1 + s_{11}) - s_{12} s_{21}} \end{array} \right]$$

The y-parameters in these equations are standardized to Z_0 .

The real y-values are $y_{ik} = y'_{ik}$; Z_0 ; $i, k = 1, 2$

Relationship between S-Parameters and h-Parameters

$$s_{11} = \frac{(h'_{11} - 1)(h'_{22} + 1) - h'_{12} h'_{21}}{(h'_{11} + 1)(h'_{22} + 1) - h'_{12} h'_{21}}$$

$$h'_{11} = \frac{(1 + s_{11})(1 + s_{22}) - s_{12} s_{21}}{(1 - s_{11})(1 + s_{22}) + s_{12} s_{21}}$$

$$s_{12} = \frac{2h'_{12}}{(h'_{11} + 1)(h'_{22} + 1) - h'_{12} h'_{21}}$$

$$h'_{12} = \frac{2s_{12}}{(1 - s_{11})(1 + s_{22}) + s_{12} s_{21}}$$

$$s_{21} = \frac{-2h'_{21}}{(h'_{11} + 1)(h'_{22} + 1) - h'_{12} h'_{21}}$$

$$h'_{21} = \frac{-2s'_{21}}{(1 - s_{11})(1 + s_{22}) + s_{12} s_{21}}$$

$$s_{22} = \frac{(1 + h'_{11})(1 - h'_{22}) + h'_{12} h'_{21}}{(h'_{11} + 1)(h'_{22} + 1) - h'_{12} h'_{21}}$$

$$h'_{22} = \frac{(1 - s_{22})(1 - s_{11}) - s_{12} s_{21}}{(1 - s_{11})(1 + s_{22}) + s_{12} s_{21}}$$

The h -parameter in these equations are standardized to Z_0

The real h -values are: $h_{11} = h'_{11} Z_0$; $h_{12} = h'_{12}$; $h_{21} = h'_{21}$; $h_{22} = \frac{h'_{22}}{Z_0}$

2.5.7. Physical Equivalent Circuits of Transistors

Apart from describing the characteristics of a transistor by means of four-pole matrix parameters (formal equivalent circuits), it is also possible to use a representation in the form so-called physical equivalent circuits. The characteristics sometimes state elements of these equivalent circuits.

π -Equivalent Circuit of a Transistor (according to Giacoletto; Common Emitter Circuit)

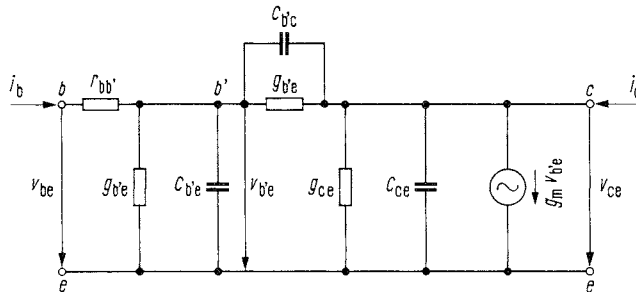

Relations between the y -Parameters and the Elements of the π -Equivalent Circuit

$$\begin{pmatrix} Y_{11e} & Y_{12e} \\ Y_{21e} & Y_{22e} \end{pmatrix} = \frac{1}{M} \begin{pmatrix} Y_{b'c} + Y_{b'e} & -Y_{b'c} \\ g_m - Y_{b'c} & (Y_{b'c} + Y_{ce}) \cdot M + r_{bb'} \cdot Y_{b'c} (g_m - Y_{b'c}) \end{pmatrix}$$

$$Y_{b'c} = g_{b'c} + j \omega C_{b'c}$$

$$Y_{ce} = g_{ce} + j \omega C_{ce}$$

$$Y_{b'e} = g_{b'e} + j \omega C_{b'e}$$

$$M = 1 + (Y_{b'c} + Y_{b'e}) r_{bb'}$$

Radio-Frequency T-Equivalent Circuit of a Transistor (Common Base Circuit)

This equivalent circuit is not suitable for application in the AF range.

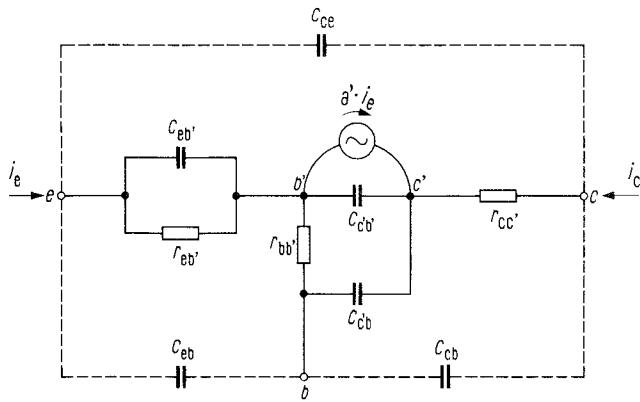

2.6. Germanium Diodes

Germanium diodes are point-contact diodes consisting of a germanium wafer against which a spring-loaded metal point is pressed. This assembly is contained in a glass case which protects it against external influences. The essential element of a diode is the PN junction, produced by subjecting the area around the point contact to a forming current pulse. The diameter of this area is very small, its intrinsic capacitance is also small and for this reason germanium diodes may be used up to very high operating frequencies.

Usually such diodes are made by using N-type germanium.

The back electrode of the crystal forms the cathode, while the wire spring represents the anode. A ring of white colour on the glass case or a colour cap indicates the cathode. The diode is operated in forward direction if the negative pole of the battery supply is connected to the cathode.

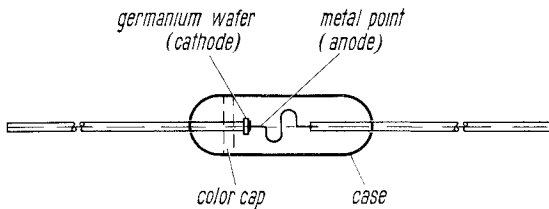

Different types of diodes display different characteristics to suit specific applications. A distinction is made, for instance, between:

Radio-frequency diodes, for high-resistance or low-resistance rectifier circuits (AA 119 or AA 116).

2.6.1. Maximum Ratings

The maximum ratings indicate the load to which the diodes may be subjected. They are permissible maximum values of the electrical and thermal quantities which must not be exceeded jointly or individually. In case of sine-wave or square-wave loads, the maximum permissible peak values (maximum reverse voltage and maximum forward current) apply in conjunction with operating frequency or duty cycle data. With the diodes used for rectification, the permissible value of the rectified current depends on the reverse voltage present when current does not flow. If voltages of random wave form are applied to the diode, the integration time t_{av} has to be taken into account. The following maximum ratings are listed:

V_R = maximum DC reverse voltage.

V_{RM} = maximum peak reverse voltage, peak value of the AC reverse voltage at an operating frequency > 20 Hz with a sine-wave control voltage as well as with a square-wave control voltage.

I_0 = rectified current = arithmetical mean of the diode current. For rectifier circuits with resistive and capacitive load and sine-wave AC input voltage, I_0 can be obtained from the appropriate limit curve $I_0 = f(V_{RM})$.

With decreasing duty cycle (pulse length/cycle duration) and with constant rectified current, the effective current flowing through the diode and consequently the load on the diode increase.

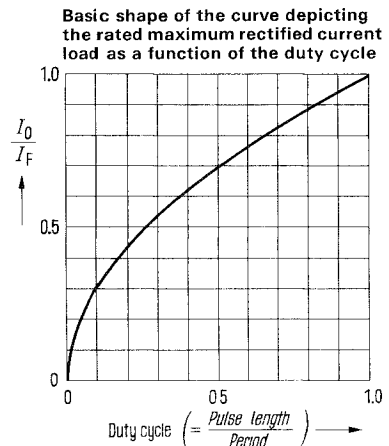

For higher ambient temperatures T_{amb} the equation for I_o

$$\frac{I_o (T_{\text{amb}})}{I_o (25^\circ\text{C})} = \frac{T_j - T_{\text{amb}}}{T_j - 25}$$

i_{FM} = maximum peak forward current at an operating frequency > 20 Hz with a sine-wave control voltage as well as with a square-wave control voltage.

i_{FS} = maximum value of the forward current that may flow for a maximum of 1 s. Not permissible as an operating value since repetitions may adversely affect the service life characteristics.

t_{av} = integration time = period during which the mean value of current or voltage must not exceed the corresponding DC values stated under maximum ratings. At the same time the instantaneous values must *not* exceed the maximum permissible peak values specified in the data sheets.

2.6.2. The Static Characteristics

indicate the DC behaviour. A distinction is made here between data for the forward and reverse directions. Both ranges show differences in temperature behaviour. The change in forward voltage drop is approx. 2 mV/K. In case of small voltages the temperature coefficient of the reverse current is approx. 7%/K and drops to approx. 2%/K near breakdown.

2.6.3. The Dynamic Characteristics

describe the RF behaviour of a diode. For this purpose, the voltage rectifying relation η_v and the loss resistance R_d are quoted. These data apply to a specified measuring circuit and operating frequency. The voltage rectification relation η_v is the quotient of the rectified voltage and the peak value of the RF input voltage (as a measure of the efficiency of the rectification of AC voltages). The loss resistance is the RF input resistance of a loaded rectifier circuit, i. e., the equivalent parallel resistance of the diode as seen from the oscillating circuit. In case of voltages of a few volts the parallel resistance may drop to the minimum value $R_L/2$.

In the case of switching diodes, the reverse delay time t_{rr} is indicated. It signifies the time required for removing the charge carriers in the PN-junction after a preceding load in forward direction. For a clear definition of t_{rr} , a special measuring circuit which suits the behaviour of the respective type of diode particularly well, is indicated.

2.7. Silicon Diodes

Silicon diodes, are distinguished by low reverse currents, high reverse voltages and large slope. The high, typical permissible junction temperature T_j of 150 °C permits comparatively large dissipations and a large operating range.

2.7.1. Current-Voltage Characteristic

The current-voltage characteristic, after having passed the threshold voltage of 0.6 to 0.7 V, rises steeply, has extraordinarily small reverse currents in the reverse region (in the order of nanoamperes), and displays a very steep breakdown characteristic compared to Germanium diodes, after a certain reverse voltage has been exceeded.

2.7.2. Temperature Dependence

The three regions of the current-voltage characteristic described show differences in temperature behaviour. The reverse current and the forward slope increase with temperature. As the reverse currents are extremely low, their temperature dependence may be neglected. The temperature dependence of the breakdown voltage is a function of the respective breakdown voltage quantity.

2.7.3. Load Carrying Capacity

The thermal resistance R_{thamb} for silicon diodes in metal cases is ≤ 500 K/W, and for those in DO-7 glass cases ≤ 400 K/W, always between junction and static ambient air. For metal cased diodes the thermal resistance can be considerably reduced by means of a heat sink and chassis mounting. In the data sheets a thermal resistance of $R_{thL} \leq 350$ K/W is indicated for chassis mounting on 12 cm² of 2 mm thick aluminium sheet. Thermal resistance between junction and case is ≤ 250 K/W.

According to the relation
$$P_{tot} = \frac{T_j - T_{amb}}{R_{th}}$$

and on the basis of the maximum permissible junction temperature $T_j = +150$ °C at an ambient temperature of 45 °C, the permissible dissipation $P_{tot} = 210$ mW is obtained for metal-cased diodes, and $P_{tot} = 250$ mW for glass-cased DO-7 diodes when operated in static ambient air. When cooled as mentioned above, the permissible dissipation of metal-cased diodes is 300 mW.

For miniature glass-case diodes, the following relation exists between thermal resistance R_{thamb} and the distance case to soldered joint.

Thermal resistance as a function of wire length between diode case and soldered joint of leads

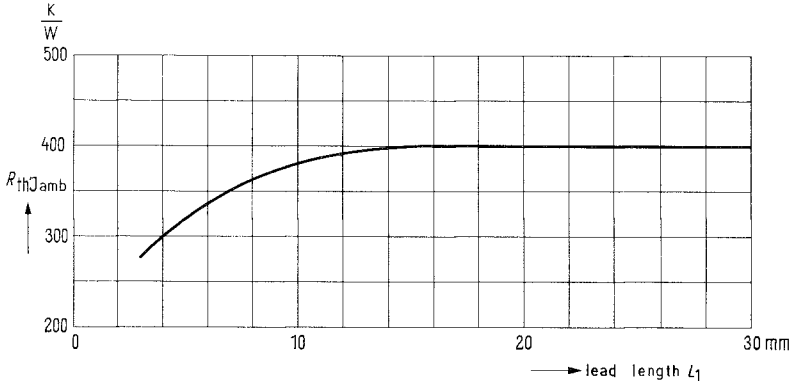

L_1 = Lead length between soldered joint and glass case, the joints being maintained at 25 °C.

2.7.4. Capacitance Diodes

Capacitance diodes are used in circuits for automatic fine tuning, electronic tuned circuits, as capacitive couplings in filters with a variable bandwidth and as modulators.

The simplified equivalent RF circuit diagram of the capacitance diode operated in a reverse direction consists of the series circuit made up of the series inductance L_s , the series resistance R_s , and the junction capacitance C_j . In case of frequencies up to the VHF range L_s may be neglected.

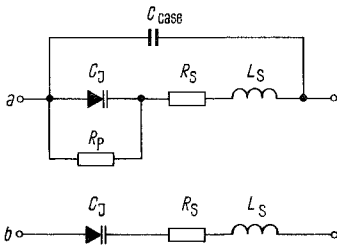

- C_{case} Case capacitance
- C_j Junction capacitance
- R_p Equivalent resistance of junction
- R_s Series resistance
- L_s Series inductance

- a) Equivalent circuit diagram of the capacitance diode
- b) Simplified RF equivalent circuit diagram

The junction capacitance C depends on the reverse voltage applied across the diode

$$C_j = \frac{C_{j0}}{\left(1 + \frac{V_R}{V_D}\right)^n}$$

C_{j0} = junction capacitance without an external bias

V_D = diffusion voltage, in case of silicon diodes approx. 0.7 V

n = magnitude influenced by the diode manufacturing process.

While diffused diodes with a linear impurity transition have $n = 0.33$ the diffused epitaxial planar diodes with an approximately abrupt PN transition, as are commonly used today, have a n of about 0.45 to 0.48. Using special diffusion processes diodes with a hyperabrupt PN transition and $n > 0.5$ may be produced characterized by a very large useful capacitance change. They are thus particularly suitable for tuning large frequency ranges (e. g. BB 105 for VHF). For these diodes, n is a function of the reverse voltage.

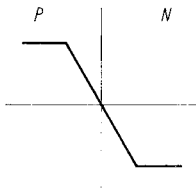

linear $n = \text{const.} \approx 0.33$

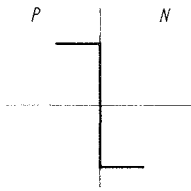

abrupt $n = \text{const.} \approx 0.5$

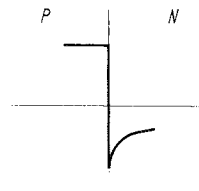

hyperabrupt $n = f(V_R)$

The quality of a capacitance diode is calculated using the capacitance C_j , the series resistance R_s and the frequency f in accordance with the following formula:

$$Q = \frac{1}{2 \pi f C_j R_s}$$

The series resistance R_s decreases with an increasing bias.

The nonlinearity of the capacitance characteristic results in a signal distortion of the transfer curve in case of a large ratio between signal amplitude and applied voltage. To reduce the disturbing amplitude and phase distortions in filter circuit applications and to achieve high-quality operation, tuning diodes are employed characterized by as high a reverse voltage as possible.

Through a push-pull arrangement of two diodes the distortions may be kept small even in case of large modulations because the signal will modulate the diodes in antiphase and the capacitance changes of the diodes will be equalized in the first approximation. For this type of application in the VHF range, for instance, the diode BB 104 is available.

The temperature coefficient of the junction capacitance decreases with an applied reverse voltage and amounts to approx. $3 \times 10^{-4}/K$ at $V_R = 3$ V. This is caused by the declining diffusion voltage V_D with rising temperature.

2.7.5. PIN Diodes

PIN diodes, in contrast to other diodes, are semiconductor diodes carrying a zone of extremely weakly doped high-resistivity material between the P and N areas, the – almost – “intrinsic zone” (*I*-zone). As a genuine *I* conductivity is virtually impossible the high-resistivity zone is always of a P or N conducting type which is sometimes indicated by the designation ν or π zone.

In electronic engineering PIN diodes serve as low-loss switches of small self-capacitance and as continuous AGC's. Typical applications in TV engineering are as VHF band switching diodes (BA 182) or as AGC tuner diodes (BA 379).

Their technological structure and equivalent circuit diagram are shown below.

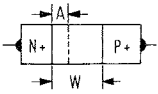

Structural diagram of a PIN diode
 W = Length of *I*-zone
 A = Space-charge area

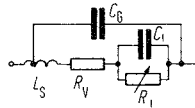

RF equivalent circuit diagram
 L_s, C_{case} are case portions

The width A of the space-charge region depends on the voltage applied to the diode; in the reverse region its maximum width corresponds to the width W of the *I*-zone. A represents the dielectric of a loss-free capacitor C_A ; the area $W \cdot A$ electrically constitutes the parallel connection of a high resistance and a small resistance. At a low frequency C_A is contacted by $P+$ and $N+$, N_v . C_A is then the diode capacitance and its voltage dependence is measurable. At a high frequency the capacitive admittance prevails in the N_v region ($W \cdot A$); the capacitance C_i of the *I*-zone of W -length, which is characterized by an equivalent resistance R_i , is to be measured as the total admittance of the diode approximately independent of voltage.

At forward currents I_F electrons and holes are injected into the *I*-zone, reducing the resistance R_i .

For a distortion-free passage of an AC current i_f the total load must always remain constant, i. e. the life τ of the charge carriers must be considerably higher than the period of the AC current.

The resistance R_i has to be reduced according to

$$R_i \approx \frac{W^2}{\tau \cdot I_F}$$

by I_F in such a way that the resistance R_v formed by the contact resistances and the remaining series resistances of the $P+$, $N+$ regions predominantly determines the total resistance r_i . The diode impedance is thus adjustable from the reversed conditions

$$\frac{1}{\omega (C_i + C_{case})}$$

to the forward condition: $r_{fmin} = R_v$. The adjustment to the respective application as a switch or variable linear RF resistance is warranted by its optimum technological design.

3. STANDARD Types

3.1. Transistors

Inventory of Discrete Standard Types

3.1.1 Inventory of Types: Transistors

Type (P=PNP) (N=NPN)		Collector- base reverse voltage V_{CBO} ; V	Collector current I_C ; mA	Current- gain band- width product f_T ; MHz	Thermal resistance R_{thJamb} ; K/W ($R_{thJcase}$; K/W)	Case K = cooling block	Page
AC 121	P	20	300	1.5	≤ 300 (50)	TO-1 sim	76
■ AC 127	N	32	500	2.5	≤ 370 (110)	TO-1 sim	83
AC151(r)	P	32	200	1.5	≤ 300 (50)	TO-1 sim	87
AC 152	P	32	500	1.5	≤ 300 (50)	TO-1 sim	76
AC 153	P	32	2000	1.5	≤ 300 (40)	TO-1 sim	93
AC 153 K	P	32	2000	1.5	≤ 300 (45) ¹⁾	K	93
AC 162	P	32	200	1.7	≤ 300 (50)	TO-1 sim	99
AC 163	P	32	200	2.3	≤ 300 (50)	TO-1 sim	99
AC 176	N	32	1000	3	≤ 300 (40)	TO-1 sim	106
AC 176 K	N	32	1000	3	≤ 300 (45) ¹⁾	K	106
AC 187 K	N	25	2000	5	≤ 45 ¹⁾	K	108
AC 188 K	P	-25	-2000	1.5	≤ 45 ¹⁾	K	112
■ AD 130	P	-32	-3000	0.35	(≤ 1.5)	TO-3	116
■ AD 131	P	-64	-3000	0.35	(≤ 1.5)	TO-3	116
■ AD 132	P	-80	-3000	0.35	(≤ 1.5)	TO-3	116
■ AD 133	P	-50	-15000	0.3	(≤ 1.5)	TO-41 sim	123
AD 136	P	-40	-10000	0.3	(≤ 5)	TO-8	128
■ AD 148	P	-32	-3500	0.45	(≤ 4)	SOT-9	133
■ AD 149	P	-50	-3500	0.5	(≤ 2)	TO-3	136
■ AD 150	P	-32	-3500	0.45	(≤ 2)	TO-3	136
AD 161	N	32	3000	3	(≤ 4.5)	SOT-9	140
AD 162	P	-32	-3000	1.5	(≤ 4.5)	SOT-9	146
■ AD 163	P	-100	-3000	0.35	(≤ 1.5)	TO-3	116
AF 106	P	-25	-10	220	≤ 750 (400)	TO-72	151
AF 109 R	P	-20	-10	280	≤ 750 (400)	TO-72	157

■ Not for new development

¹⁾ Thermal resistance between junction and heat sink under the fastening screw (R_{thL})

3.1.1. Inventory of Types: Transistors

Type (P = PNP) (N = NPN)	Collector-base reverse voltage V_{CB0} ; V (V_{CES}); V	Collector current I_C ; mA (I_{CM}); mA	Current- gain band- width product f_T ; MHz	Thermal resistance R_{thJamb} ; K/W ($R_{thJcase}$); K/W	Case	Page
AF 139 R	P -20	-10	550	≤750 (400)	TO-72	162
■ AF 200 U	P -25	-10	210	≤750 (400)	TO-72	170
AF 201 U	P -25	-10	220	≤750 (400)	TO-72	170
■ AF 202	P -25	-30	210	≤450 (200)	TO-72 sim	176
■ AF 202 S	P -32	-30	210	≤450 (200)	TO-72 sim	176
AF 239	P (-20)	-10	700	≤750 (400)	TO-72	180
AF 239 S	P (-20)	-10	780	≤750 (400)	TO-72	186
AF 240	P (-20)	-10	500	≤750 (400)	TO-72	190
■ AF 279	P (-20)	-10	780	≤600	TO-50 sim	193
▼ AF 279 S	P (-20)	-10	820	≤600	TO-50 sim	195
AF 280	P (-20)	-10	550	≤600	TO-50 sim	197
▼ AF 306	P (-25)	-15	500	≤500	TO-92 sim	199
▼ AF 379	P (-20)	-20	1250	≤450	TO-50 sim	201
BC 107	N (50)	(200)	250	≤500 (200)	TO-18	203
BC 108	N (30)	(200)	250	≤500 (200)	TO-18	203
BC 109	N (30)	50	300	≤500 (200)	TO-18	203
BC 110	N 80	50	100	≤500 (200)	TO-18	212
BC 121	N 5	75	250	≤1000	U 32	214
BC 122	N 30	75	250	≤1000	U 32	214
BC 123	N 45	75	250	≤1000	U 32	214
BC 140	N 80	1000	50	≤200 (35)	TO-39	222
BC 141	N 100	1000	50	≤200 (35)	TO-39	222
BC 147	N (50)	(200)	250	≤420	SOT-25	228
BC 148	N (30)	(200)	250	≤420	SOT-25	228
BC 149	N (30)	50	300	≤420	SOT-25	228
BC 157	P (-50)	(-200)	130	≤420	SOT-25	237

▼ New type ■ Not for new development

3.1.1. Inventory of Types: Transistors

Type (P = PNP) (N = NPN)	Collector- base reverse voltage V_{CBO} ; V (V_{CES}); V	Collector current I_C ; mA (I_{CM}); mA	Current- gain band- width product f_T ; MHz	Thermal resistance R_{thJamb} ; K/W ($R_{thJcase}$); K/W	Case	Page
BC 158	P (-30)	(-200)	130	≤ 420	SOT-25	237
BC 159	P (-25)	-50	130	≤ 420	SOT-25	237
BC 160	P -40	-1000	>50	$\leq 200(35)$	TO-39	246
BC 161	P -60	-1000	>50	$\leq 200(35)$	TO-39	246
BC 167	N (50)	(200)	250	≤ 420	TO-92	252
BC 168	N (30)	(200)	250	≤ 420	TO-92	252
BC 169	N (30)	50	300	≤ 420	TO-92	252
BC 177	P (-50)	(-200)	130	$\leq 500(200)$	TO-18	261
BC 178	P (-30)	(-200)	130	$\leq 500(200)$	TO-18	261
BC 179	P (-25)	-50	130	$\leq 500(200)$	TO-18	261
BC 182	N 60	200	≥ 150	≤ 420	TO-92 sim	270
BC 201	P -5	-75	80	≤ 1000	U 32	277
BC 202	P -30	-75	80	≤ 1000	U 32	277
BC 203	P -45	-75	80	≤ 1000	U 32	277
BC 212	P -60	-200	200	≤ 420	TO-92 sim	285
BC 237	N (50)	(200)	250	≤ 420	TO-92 sim	292
BC 238	N (30)	(200)	250	≤ 420	TO-92 sim	292
BC 239	N (30)	50	300	≤ 420	TO-92 sim	292
BC 257	P (-50)	(-200)	130	≤ 420	TO-92	300
BC 258	P (-30)	(-200)	130	≤ 420	TO-92	300
BC 259	P (-25)	-50	130	≤ 420	TO-92	300
BC 307	P (-50)	(-200)	130	≤ 420	TO-92 sim	309
BC 308	P (-30)	(-200)	130	≤ 420	TO-92 sim	309
BC 309	P (-25)	-50	130	≤ 420	TO-92 sim	309
BC 327	P (-50)	-800	100	≤ 200	SOT-30	317
BC 328	P (-30)	-800	100	≤ 200	SOT-30	317

3.1.1. Inventory of Types: Transistors

Type (P = PNP) (N = NPN)	Collector- base reverse voltage V_{CB0} ; V (V_{CES}); V	Collector current I_C ; mA (I_{CM}); mA	Current- gain band- width product f_T ; MHz	Thermal resistance R_{thJamb} ; K/W ($R_{thJcase}$); K/W	Case	Page
BC 337	N (50)	800	100	≤ 200	SOT-30	322
BC 338	N (30)	800	100	≤ 200	SOT-30	322
BC 413	N 45	100	250	≤ 420	TO-92 sim	327
BC 414	N 50	100	250	≤ 420	TO-92 sim	327
BC 415	P - 45	-100	200	≤ 400	TO-92 sim	335
BC 416	P - 50	-100	200	≤ 400	TO-92 sim	335
▼ BC 546	N 80	100	300	≤ 250	TO-92 sim	343
▼ BC 547	N 50	100	300	≤ 250	TO-92 sim	343
▼ BC 548	N 30	100	300	≤ 250	TO-92 sim	343
▼ BC 549	N 30	100	300	≤ 250	TO-92 sim	349
▼ BC 550	N 50	100	300	≤ 250	TO-92 sim	349
▼ BC 556	P - 80	-100	150	≤ 250	TO-92 sim	355
▼ BC 557	P - 50	-100	150	≤ 250	TO-92 sim	355
▼ BC 558	P - 30	-100	150	≤ 250	TO-92 sim	355
▼ BC 559	P - 30	-100	300	≤ 250	TO-92 sim	361
▼ BC 560	P - 50	-100	300	≤ 250	TO-92 sim	361
■ BD 109	N 60	3000	>30	(≤ 7)	SOT-9	367
BD 130	N 100	15000	1.1	(≤ 1.5)	TO-3	372
BD 135	N 45	1500	>50	$\leq 110(8.4)$	TO-126	377
BD 136	P - 45	-1500	>75	$\leq 110(8.4)$	TO-126	382
BD 137	N 60	1500	>50	$\leq 110(8.4)$	TO-126	377
BD 138	P - 60	-1500	>75	$\leq 110(8.4)$	TO-126	382
BD 139	N 100^1)	1500	>50	$\leq 110(8.4)$	TO-126	377
BD 140	P - 100^1)	-1500	>75	$\leq 110(8.4)$	TO-126	382
▼ BD 433	N 22	4000	>3	<100	TO-126	387
▼ BD 434	P - 22	-4000	>3	<100	TO-126	392

¹⁾ V_{CER}

▼ New type

■ not for new development

3.1.1. Inventory of Types: Transistors

Type (P=PNP) (N=NPN)	Collector- base reverse voltage V_{CB0} ; V	Collector current I_C ; A (I_{CM} ; A)	Current- gain band- width product f_T ; MHz	Thermal resistance R_{thJamb} ; K/W	Case	Page
▼ BD 435	N 32	4000	>3	<100	TO-126	387
▼ BD 436	P -32	-4000	>3	<100	TO-126	392
▼ BD 437	N 45	4000	>3	<100	TO-126	387
▼ BD 438	P -45	-4000	>3	<100	TO-126	392
▼ BD 439	N 60	4000	>3	<100	TO-126	387
▼ BD 440	P -60	-4000	>3	<100	TO-126	392
▼ BD 441	N 80	4000	>3	<100	TO-126	387
▼ BD 442	P -80	-4000	>3	<100	TO-126	392

Inventory of Types: Power Darlington Stages

Forward Current Transfer Ratio $h_{FE} = 750$ to 2000

▼ BD 643	N 45	8 (15)	>1	<80	TOP-66	397
▼ BD 644	P -45	-8(-15)	>1	<80	TOP-66	401
▼ BD 645	N 60	8 (15)	>1	<80	TOP-66	397
▼ BD 646	P -60	-8(-15)	>1	<80	TOP-66	401
▼ BD 647	N 80	8 (15)	>1	<80	TOP-66	397
▼ BD 648	P -80	-8(-15)	>1	<80	TOP-66	401
▼ BD 649	N 100	8 (15)	>1	<80	TOP-66	397
▼ BD 650	P -100	-8(-15)	>1	<80	TOP-66	401
▼ BD 675	N 45	4 (7)	>1	<100	TOP-66	405
▼ BD 676	P -45	-4(-7)	>1	<100	TOP-66	409
▼ BD 677	N 60	4 (7)	>1	<100	TOP-66	405
▼ BD 678	P -60	-4(-7)	>1	<100	TOP-66	409
▼ BD 679	N 80	4 (7)	>1	<100	TOP-66	405
▼ BD 680	P -80	-4(-7)	>1	<100	TOP-66	409

▼ New type

3.1.1. Inventory of Types: Transistors

Type (P = PNP) (N = NPN)		Collector- base reverse voltage V_{CB0} ; V (V_{CES}); V	Collector current I_C ; mA (I_{CM}); mA	Current- gain band- width product f_T ; MHz	Thermal resistance R_{thJamb} K/W ($R_{thJcase}$); K/W	Case	Page
BF 194	N	30	30	260	≤ 450	SOT-25	413
BF 195	N	30	30	200	≤ 450	SOT-25	413
BF 198	N	40	25	400	≤ 420	TO-92	421
BF 199	N	40	25	550	≤ 420	TO-92	426
BF 240	N	40	25	400	≤ 420	TO-92	430
BF 241	N	40	25	400	≤ 420	TO-92	430
BF 254	N	30	30	260	≤ 450	TO-92	432
BF 255	N	30	30	200	≤ 450	TO-92	432
BF 324	N	- 30	- 25	350	≤ 420	TO-92	435
▼ BF 362	N	30	20	800	≤ 580	TO-50 sim	439
▼ BF 363	N	30	20	800	≤ 580	TO-50 sim	439
BF 450	P	- 40	- 25	325	≤ 660	TO-92	441
BF 451	P	- 40	- 25	325	≤ 660	TO-92	441
BF 457	N	160	100	90	(≤ 104 (10))	TO-126	446
BF 458	N	250	100	90	(≤ 104 (10))	TO-126	446
BF 459	N	300	100	90	(≤ 104 (10))	TO-126	446
BU 110	N	(330)	10000	25	($\leq 1,66$)	TO-3 sim	450
BU 111	N	(400)	6000	20	(≤ 2)	TO-3	453
BU 114	N	(250)	6000	20	(≤ 2)	TO-3	453
▼ BU 126	N	750 ¹⁾	3000	> 8	(≤ 2.5)	TO-3	457
▼ BU 208	N	(1500)	5000	-	(≤ 1.6)	TO-3	460
▼ BU 310	N	160 ¹⁾	6000	25	(≤ 3)	TO-3	463
▼ BU 311	N	200 ¹⁾	6000	25	(≤ 3)	TO-3	463
▼ BU 312	N	280 ¹⁾	6000	25	(≤ 3)	TO-3	463

¹⁾ V_{CES}

▼ New type

For AF pre- and driver stages und AF power stages of medium output

The above transistors are germanium alloyed PNP transistors in metal case 1A 3 DIN 41871 (similar to TO-1) designed for application in AF pre- and driver stages and AF power stages. AC 121, AC 152 are specially for use in AF driver and power stages of medium output.

The leads of these transistors are electrically insulated from the case. The collector terminal is marked by a red dot at the rim of the case. The transistors AC 121 and AC 152 are available in pairs. Together with AC 127, the AC 152 is also available in complementary pairs.

For mounting on a chassis, a mounting flange (heat sink) is provided for which has to be ordered separately.¹⁾

Type	Order number	Type	Order number
AC 121 IV	Q60103-D121	AC 152 IV	Q60103-X152-D
AC 121 V	Q60103-E121	AC 152 V	Q60103-X152-E
AC 121 VI	Q60103-F121	AC 152 VI	Q60103-X152-F
AC 121 VII	Q60103-G121	AC 152 paired	Q60103-X152-P
AC 121 paired	Q60103-P121-X1	AC 152 compl. paired	Q60103-X152-S12
		AC 152/ AC 127 paired	Q60103-P127-D
		Heat sink	Q62901-B1

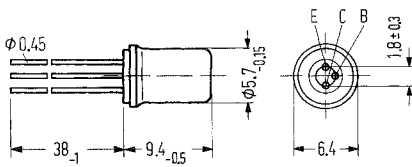

Weight approx. 1 g Dimensions in mm

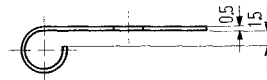
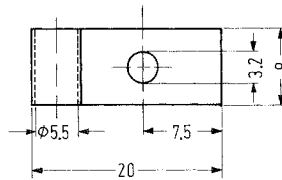

Weight approx. 2 g

¹⁾ With careful mounting, thermal resistance between transistor case and heat sink under fastening screw $R_{th} \leq 10 \text{ K/W}$

K-code to DIN-41882	K1,1	K1,1	K1,1	K1,1	K0,55	K0,55	Extrusions			
type	56278	56313	56314	56280	56318	56315	56230	56231	56290	56293
BYX38							●		●	
BYX39							●		●	
BYX50							●		●	
1N3880/81/82							●		●	
1N3890/91/92							●	●	●	
BYX98							●	●	●	
BYX42							●	●	●	
BYX99							●	●	●	
BYX30							●	●	●	
BYX25							●	●	●	
BYX46							●	●	●	
BYW30										
BYW31										
BYX96							●	●		●
BYX56	●						●	●		●
BYX97		●					●	●		●
BYX32				●		●	●	●		●
BTY79									●	
BTW38									●	
BTW42									●	
BTY87	●						●	●	●	
BTY91	●						●	●	●	
BTW47		●					●	●	●	
BTW30		●					●	●	●	
BTW45		●					●	●	●	
BTW40		●					●	●	●	
BTW92		●					●	●	●	
BTW31		●					●	●	●	
BTW24			●		●		●	●		●
BTW33				●		●				●
BTW23				●		●				●
BTW43									●	
BTX94	●						●	●	●	
BTW34			●		●		●	●		●
BTX95									●	

cases

DO-1

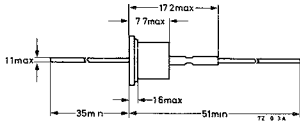

DO 7

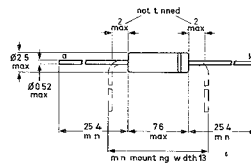

DO-4(1) 10-32 UNF or M5

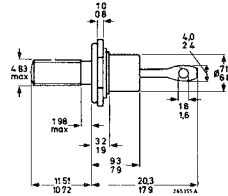

DO-14

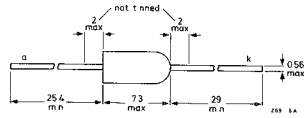

DO-4(2) 10-32 UNF or M5

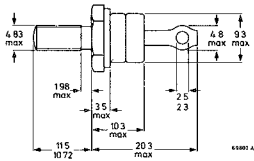

DO-15 (SOD 40)

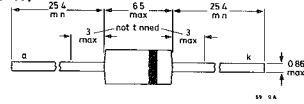

DO-4(3) 10 32 UNF or M5

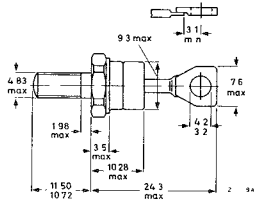

DO 30

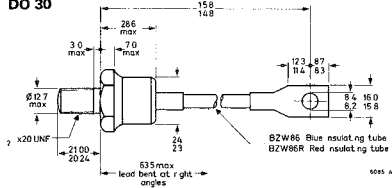

DO-5(1) 1/4" x 28 UNF or M6

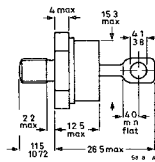

DO-35

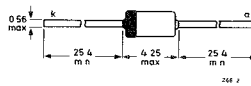

DO 5(2) 1/4" x 28 UNF or M6

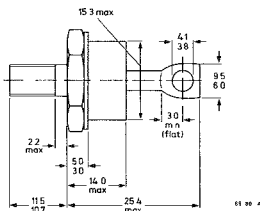

SOD 8

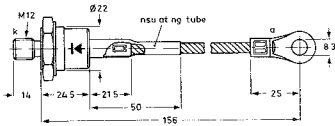

SOD 17

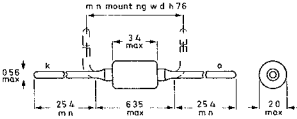

SOD 18

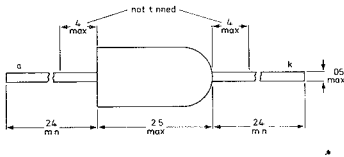

SOD 22

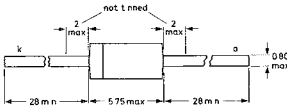

SOD 23

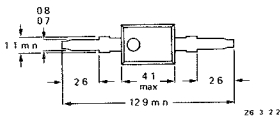

SOD 28

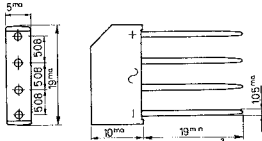

SOD 29

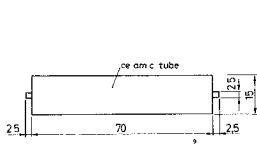

SOD 34(1) long leads

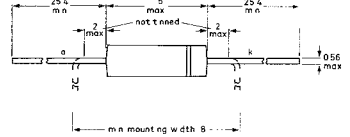

SOD 34(2) medium leads

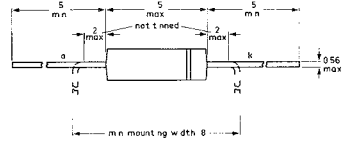

SOD 38

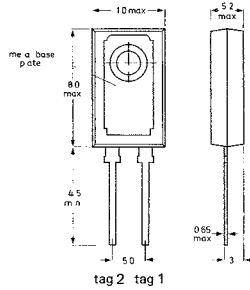

For polarity consider tag 1 = base plate as mounting base

SOD 51

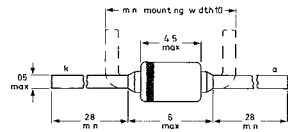

SOD 52

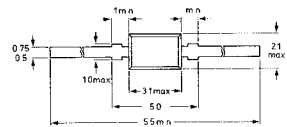

SOD 56

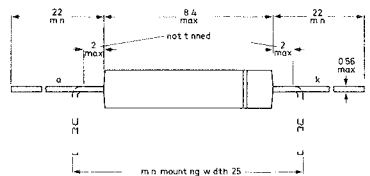

TO-1

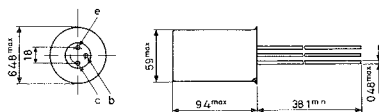

TO-1(1) with heat-conducting block

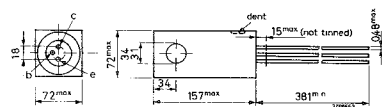

TO-3(1)

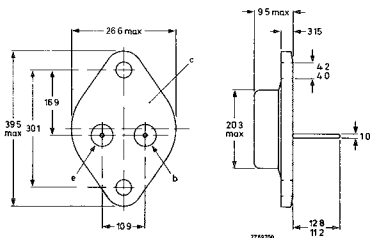

TO-3(2)

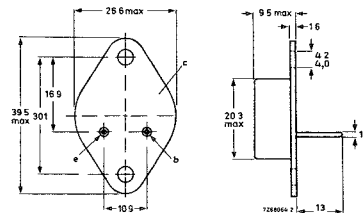

TO-5(1) collector to case

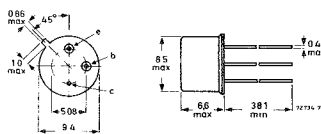

TO-5(2) base to case

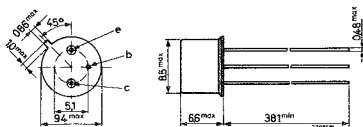

TO-18(1)

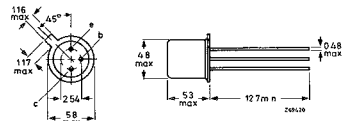

TO-18(2)

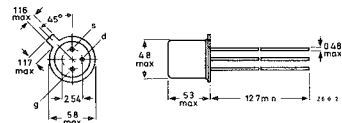

TO-18(3) (2 leads)

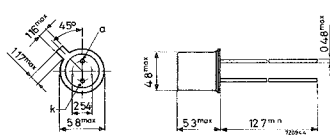

TO-39(1)

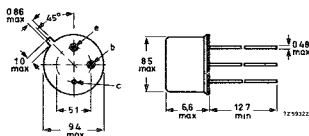

TO-39(2)

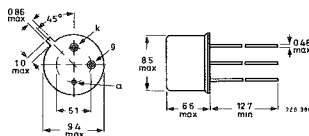

TO-48 1/4" x 28 UNF or M6

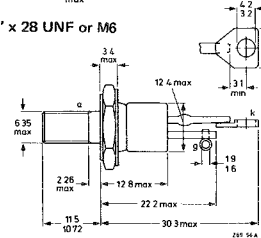

TO-60

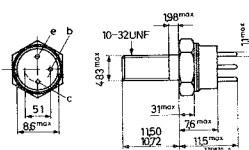

Lead diameters TO 71, TO-72 should read 0,51 max

TO-64 10 32 UNF or M5

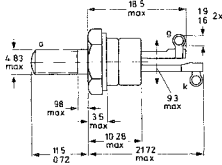

TO-66

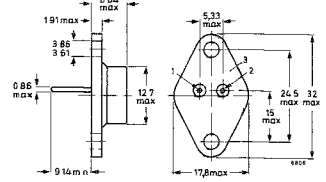

TO 71(1)

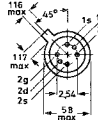

TO 71(2)

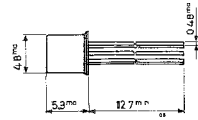
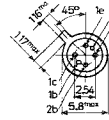

TO 72(1)

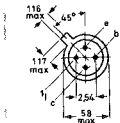

TO 72(2)

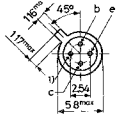

TO 72(3)

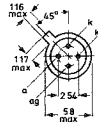

TO 72(4)

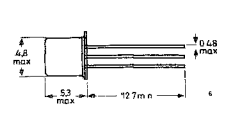
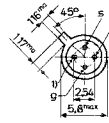

1) shield lead (connected to case)

TO 72(5)

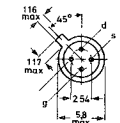

TO 72(6)

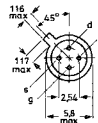

TO 72(7)

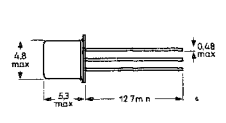
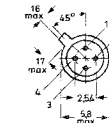

TO 92

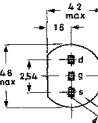

diameter with n 2,5 max is uncutted

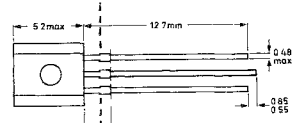

TO 92 variants

TO 92(1)

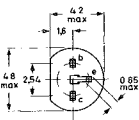

TO 92(2)

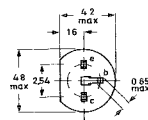

TO 92(3)

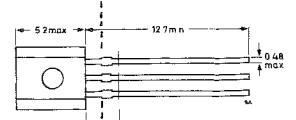
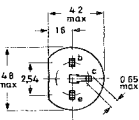

TO 92(4)

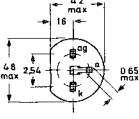

TO 92(5)

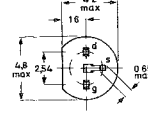

TO 92(6)

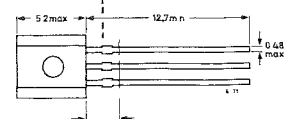
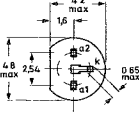

cases

TO 94 1/2 x 20 UNF or M12

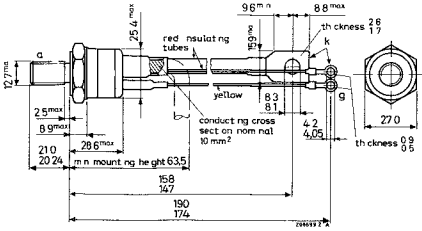

TO 220(2)

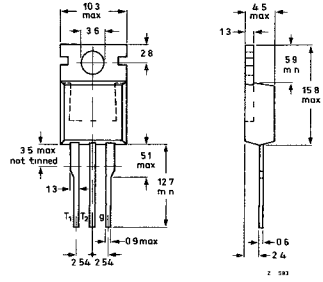

TO 103 5/16 ' x 24UNF or M8 x 1,25

triac k = T₁
a = T₂

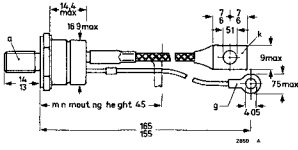

TO 126

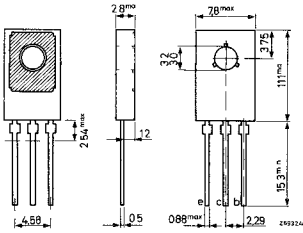

TO 220(1)

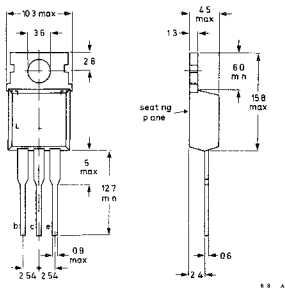

Lead diameter SOT-41 should read 0,51 max

SOT 23

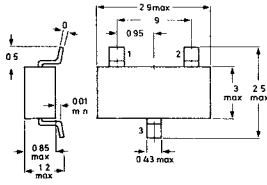

SOT 25(1)

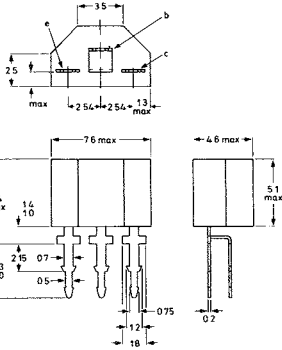

SOT 25(2)

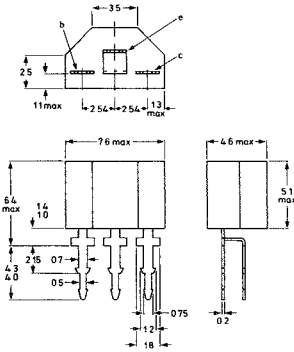

SOT-41

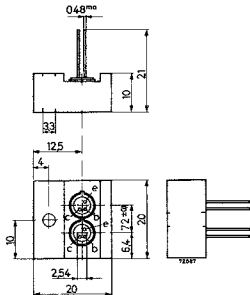

SOT 37(1)

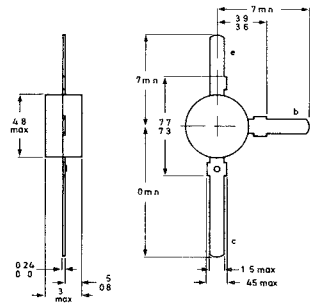

SOT 37(2)

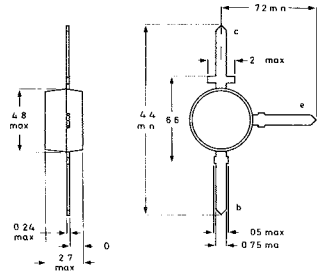

SOT 37(3)

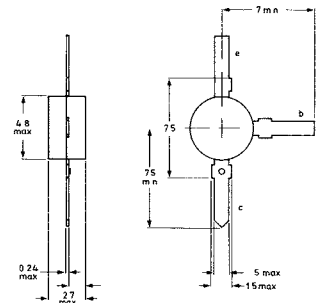

SOT 37(4)

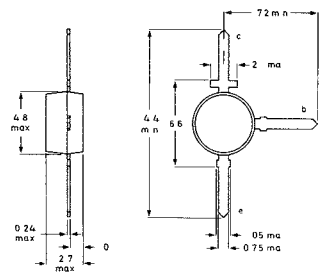

SOT-42

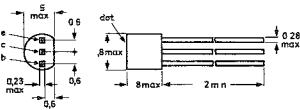

SOT-48(2)

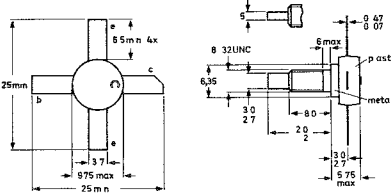

SOT 55

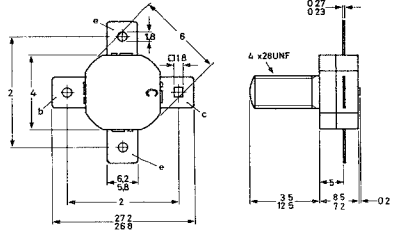

SOT-48(3)

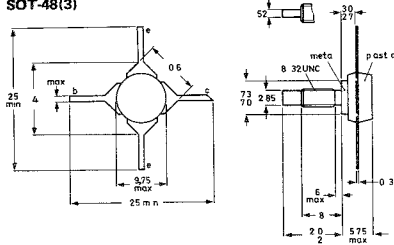

SOT 56

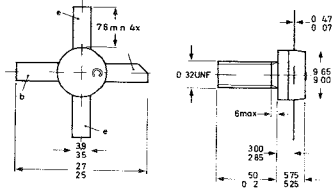

SOT-48(4)

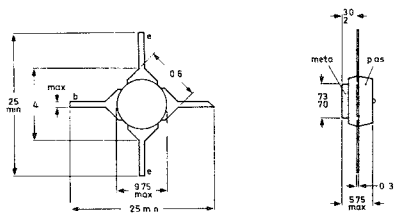

SOT 75A

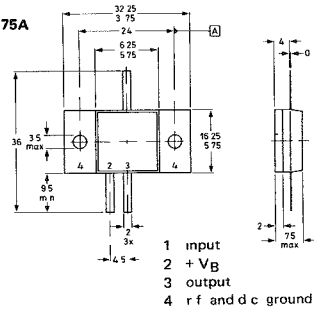

- 1 input
- 2 + V_b
- 3 output
- 4 rf and dc ground

SOT-52

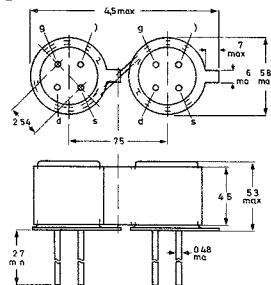

shed ead onne ed o ase

SOT-80

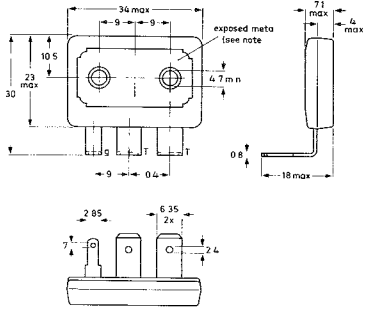

SOT 105

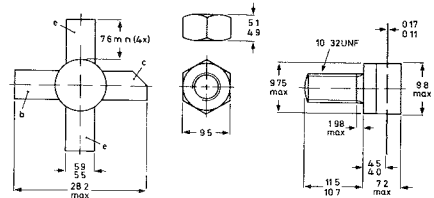

SOT 82

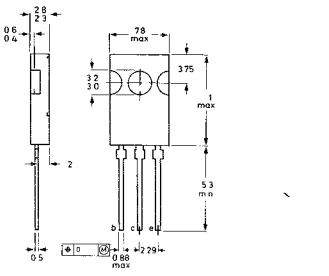

SOT 115

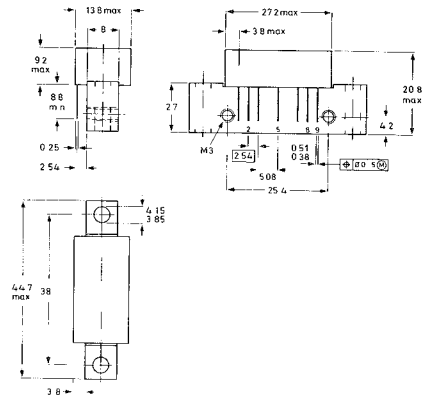

SOT 89

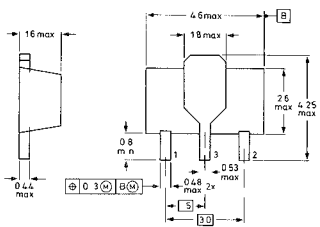

SOT 103

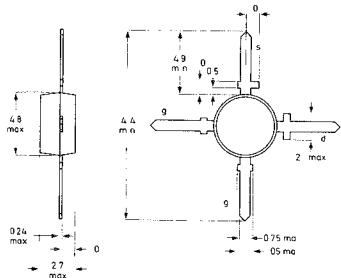

cases

BY224 and BY225

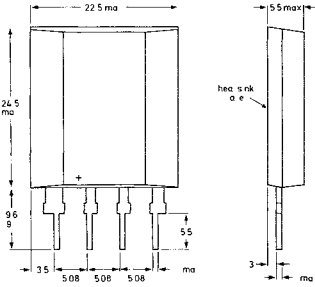

BYW29

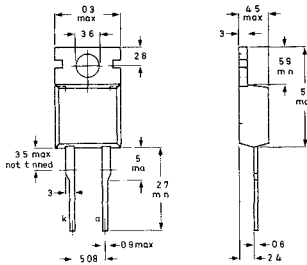

BYW54 BYW55 BYW56

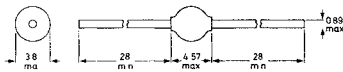

replacement guide for semiconductors

This guide consists of a list of type numbers of diodes, thyristors, triacs, and transistors (including FETs). The list combines those commonly occurring types having Pro Electron, Jedec, or Japanese type designations for which there is a known replacement, with our complete semiconductor programme, which contains some unique types.

Each of the type numbers of our programme is preceded in this list by a code letter that indicates the status of the product at 1 November 1976.

These code letters are explained in the status guide below.

An asterisk (*) beside the type number indicates a series (a range of types with one basic type number).

A "replacement" can never be an identical type to that being replaced, thus we advise that the information given in the abridged data of this catalogue be consulted and compared. Where electrical characteristics, or case, or pinning, are substantially different, the replacement type number is given in *italics*.

status guide

N = **New design type.** Recommended for new equipment design; production quantities available *after date of publication*.

D = **Design type.** Recommended for equipment design; production quantities available *at date of publication*.

C = **Current type.** No longer recommended for equipment design; available for equipment production and for use in existing equipment.

M = **Maintenance type.** No longer recommended for equipment production; available for maintenance of existing equipment as long as stocks last.

replacement guide for semiconductors

Code letter in front of type number indicates status of product at 1 November 1976 (page 95)

type to be replaced	replacement	type to be replaced	replacement	type to be replaced	replacement
A2E5	BY126	AAZ12	BAX13	AC160	AC125
A2E9	BY126	M AAZ13	AAZ18	AC161	AC125
A7D	BY126	D AAZ15		AC162	AC126
A23M	BYX39 600	D AAZ17		AC163	AC128
A23N	BYX39 800	D AAZ18		AC165	AC125
A23P	BYX39 1000	AC105	AC128	AC166	AC128
A28B	BYX30-200	AC106	AC128	AC167	AC128
A28C	BYX30 300	AC107	AC125	AC168	AC127
A28D	BYX30 400	AC108	AC126	AC169	AC125
A70M	BYX30-600	AC109	AC125	AC170	AC126
A40B	BYX96-600	AC110	AC126	AC171	AC126
A40C	BYX96 600	AC113	AC125	AC172	AC127
A40D	BYX96-900	AC114	AC128	AC173	AC127
A40E	BYX96-1200	AC115	AC126	AC174	AC128
A40M	BYX96-1200	AC116	AC126	AC175	AC187 01
A44B	BYX96-600	AC118	AC128	AC176	AC187
A44C	BYX96-600	AC119	AC128	AC177	AC128
A44D	BYX96-900	AC120	AC128	AC178	AC128 01
A44E	BYX96-1200	AC121	AC128	AC179	AC187 01
A44M	BYX96-1200	AC122	AC125	AC180	AC126
AA111	AA119	AC123	AC126	AC180K	AC128 01
AA112	AA119	AC124	AC128 01	AC181	AC127
AA113	OA91	C AC125	AC188	AC182	AC126
AA114	AA119	C AC126	AC188	AC183	AC127
AA116	OA90	C AC127	AC187	AC184	AC128
AA117	OA95	M AC127 01	AC187 01	AC185	AC127
AA118	OA95	C AC128	AC188	AC186	AC187 01
D AA119		C AC128 01	AC188 01	D AC187	
AA121	AA119	AC128A	AC188	D AC187 01	
AA123	OA90	AC128K	AC128 01	AC187K	AC187 01
AA130	OA90	AC129	2N1307	D AC188	
AA131	AA119	AC131	AC128	D AC188 01	
AA132	OA95	C AC132		AC188K	AC188 01
AA133	OA95	AC132 03	AC132	AC191	AC125
AA134	OA95	AC134	AC132	AC192	AC125
AA135	AAZ18	AC135	AC132	AC193	AC188 01
AA136	AAZ17	AC136	AC132	AC194	AC187 01
AA137	AA119	AC137	AC126	ACY16	AC128 01
AA138	OA95	AC138	AC126	ACY23	AC132
AA139	AAZ17	AC139	AC128	ACY27	ASY29
AA140	OA90	AC141	AC127	ACY28	ASY26
AA142	AA119	AC141 01	AC187 01	ACY29	ASY27
AA143	AA119	AC141K	AC187 01	ACY30	ASY27
AA144	AAZ15	AC142	AC128	ACY32	ASY26
M AAY11	OA95	AC142 01	AC128 01	ACY33	AC128
AAY12	AAZ15	AC142K	AC128 01	ACY38	AC125
AAY13	AAZ17	AC150	AC125	ACY40	AC132
AAY15	BAX13	AC151	AC125	ACZ10	AC128 01
M AAY21	AAZ18	AC151 IV	AC125	AD50	BDX92
AAY27	AAZ17	AC151 V	AC126	AD130	BD181
AAY28	AAZ15	AC151 VI	AC126	AD131	BDX96
M AAY30	AAZ17 AAZ18	AC151 VII	AC126	AD132	BDX96
M AAY32	AAZ17 AAZ18	AC152	AC132	AD136	BDX96
AAY33	AAZ18	AC153	AC128	AD138	BDX92
AAY41	AAZ18	AC153K	AC128 01	AD138 50	BDX96
AAY47	BAV10	AC154	AC128	AD139	AD162
AAY49	BAV10	AC155	AC125	AD140	BD181
AAY53	OA90	AC156	AC126	AD142	BDX96
AAY54	OA90	AC157	AC127	AD143	BDX92
AAY55	OA90	AC159	AC126	AD145	BDX92

type to be replaced	replacement	type to be replaced	replacement	type to be replaced	replacement
AD148	<i>BD434</i>	ASZ1016	BDX92	BA175	<i>BAV10</i>
AD149	<i>BD181</i>	ASZ1017	BDX92	BA176	OA91
AD150	<i>BD181</i>	ASZ1018	BDX96	BA177	<i>BA182 BA244</i>
AD152	<i>BD434</i>	AUY19	BDX92	BA179	OA200
AD153	<i>BD181</i>	AUY20	BDX96	D BA182	
AD155	<i>BD434</i>	AUY21	<i>BDX96</i>	BA184	<i>BA145</i>
AD156	<i>BD433</i>	AUY22	BDX96	BA186	<i>BA145</i>
AD157	<i>BD434</i>	AUY28	BDX96	BA187	1N4151
AD159	<i>BDX92</i>	AUY29	BDX92	BA188	<i>BAX18</i>
AD160	<i>BDX92</i>	AUY30	BDX96	BA189	<i>BAX16 BAV20</i>
M AD161	<i>BD435</i>	AUY31	BDX92	BA190	<i>BAX17 BAV21</i>
M AD162	<i>BD436</i>	AUY32	BDX92	BA195	<i>BAX17</i>
AD163	<i>BDX96</i>	AUY33	BDX92	BA209	<i>BAW62</i>
AD164	<i>BD434</i>	AUY34	BDX96	BA211	<i>BAX13 BAW62</i>
AD165	<i>BD433</i>	AUY35	BDX92	BA214	<i>BAX13 BAW62</i>
AD166	<i>BDX96</i>	AUY37	BDX96	C BA216	
AD167	<i>BDX96</i>	AUY38	BDX96	C BA217	
AD169	<i>RD434</i>	B112	<i>BD181</i>	C BA218	
AD262	<i>BD181</i>	BA101	<i>BA102</i>	C BA219	
ADY22	<i>BDX96</i>	D BA102		D BA220	
ADY25	BDX96	BA103	<i>BAV20 BAX16</i>	C BA221	
ADY27	<i>BD181</i>	BA104	<i>BAV20 BAX16</i>	C BA222	
ADY28	BDX96	BA105	<i>BA145</i>	D BA243	
AF101	AC125	BA108	<i>BAX18</i>	D BA244	
AF128	ASY27	BA109	BA102	D BA314	
M AF139		BA110	BB105G	D BA315	
M AF239		BA111	BA102	D BA316	
M AF239S		BA112	BA216 BA316	D BA317	
M AF267	AF367	M BA114	BA216 BA316	D BA318	
AF279	AF367	BA116	AA119	D BA379	
D AF367		BA119	BA102	D BAV10	
AFY14	ASY27	BA120	BB105G	D BAV17	<i>BAX18</i>
AL100	BDX96	BA121	BB106	D BAV18	
AL102	BDX96	BA124	BA102	D BAV19	
AL103	BDX96	BA125	BA102	D BAV20	
AR10	<i>BD181</i>	BA127	<i>BAX16 BAV20</i>	D BAV21	
C ASY26		BA128	<i>BAX16 BAV20</i>	D BAV45	
C ASY27		BA129	BA148	D BAV70	
C ASY28		BA130	<i>BAX13 BAW62</i>	D BAV99	
C ASY29		BA136	BA318	BAW10	<i>BAV20 BAX16</i>
ASY31	ASY26	BA137	<i>BAX16 BAV20</i>	BAW21	<i>BAV20 BAX16</i>
ASY32	ASY27	BA139	BB105G	D BAW21A	
ASY54	ASY26	BA140	BB105G	D BAW21B	
ASY55	ASY27	BA141	BB205A	BAW24	<i>BAV10</i>
ASY56	ASY26	BA142	BB105G	BAW25	<i>BAV10</i>
ASY57	ASY26	BA143	<i>BAW62 BAX13</i>	BAW26	<i>BAV10</i>
ASY58	ASY27	BA147	<i>BAV20 BAX16</i>	BAW27	<i>BAV10</i>
ASY59	ASY27	BA147 50	<i>BAW62 BAX13</i>	BAW30	<i>BAV45</i>
ASY61	ASY28	BA147 150	<i>BAV20 BAX16</i>	BAW33	<i>BAX12</i>
ASY62	ASY29	BA147 230	<i>BAV21 BAX17</i>	BAW43	<i>BAX15</i>
M ASY73		BA147 300	<i>BA145</i>	BAW45	<i>BAV20 BAX16</i>
M ASY74		BA149	BB105G	D BAW56	
M ASY75		BA150	BA102	BAW57	<i>BAX12</i>
ASZ11	ASY26	BA152	<i>BA182 BA244</i>	BAW57N	<i>BAX12</i>
ASZ12	ASY26	BA161	BB205A	D BAW62	
M ASZ15	<i>BDX96</i>	BA162	BB105G	D BAX12	
M ASZ16	<i>BDX92</i>	BA164	<i>BAW62 BAX13</i>	D BAX12A	
M ASZ17	<i>BDX92</i>	BA170	BAV10	C BAX13	
M ASZ18	<i>BDX96</i>	BA173	<i>BA145</i>	D BAX14	
ASZ1015	BDX96	BA174	<i>BA182 BA244</i>	C BAX15	

replacement guide for semiconductors

Code letter in front of type number indicates
status of product at 1 November 1976 (page 95)

type to be replaced	replacement	type to be replaced	replacement	type to be replaced	replacement
C BAX16		BAY103	BB110G	D BC147	BC547
C BAX17		BB100	BB105G	C BC148	BC548
D BAX18 BAX18A		BB100G	BB105G	C BC149	BC549
BAX20	BAV10	M BB105A	BB205A	BC153	BC557A
BAX2	BAV10	D BB105B	BB205B	BC155	BC146
BAX22	BAV20 BAX16	C BB105G	BB205G	BC156	BC146
BAX25	BAW62 BAX13	D BB106		C BC157	BC557
BAX26	BAW62 BAX13	C BB110B	BB204B	C BC158	BC558
BAX27	BAV10	C BB110G	BB204G	C BC159	BC559
BAX78	BAV10	D BB117		D BC160	
BAX84	BAV10 1N4150	BB121A	BB105B BB205B	D BC161	
BAX88	BA100	BB121B	BB106		BC547
BAX90	BA100	BB122	BB105G BB205G	BC168	BC548
BAY14	BYX10	BB139	BB106	BC169	BC549
BAY15	BYX10	BB141A	BB105B BB205B	BC170	BC548
BAY16	BYX10	BB141B	BB205A	BC171	BC547
BAY17	BAV10	D BB204B		BC172	BC548
BAY18	BAV10	D BB204G		BC173	BC549
BAY19	BAX16	D BB205A		BC174A	2N2219A
BAY20	BAX16	D BB205B		BC174B	2N2219A
BAY21	BAX145	D BB205G		D BC177	
BAY21S	BY126	D BBY31		D BC178	
BAY23	BYX10	BC26	BC179	D BC179	
BAY24	BYX10	BC100	BC180	BC180	BC547
BAY25	BYX10	D BC107	BD115	BC181	BC557
BAY31	BAW62 BAX13	D BC108		BC182	BC546
BAY32	BAV20 BAX16	D BC109		BC183	BC547
BAY33	BAV20 BAX16	BC110	BF177	BC184	BC549B
BAY36	BAV10	BC111	BC146	BC185	2N2219
BAY38	BAW62	BC112	BC146	BC186	BC177
BAY39	BAV20 BAX16	BC113	BC548B	BC187	BC177
BAY41	BAV10	BC114	BC549B	BC190A	BC107A
BAY42	BAV10	BC115	BC547	BC190B	BC107B
BAY43	BAV10	BC116	BC327	BC192	BC328
BAY44	BAV20 BAX16	BC117	BF178	BC194	BC337
BAY45	BAV20 BAX16	BC118	BC547	BC196	BC200
BAY46	BAW62 BAX13	BC119	BFY51	BC197	BC146
BAY52	BAV20 BAX16	BC120	BFY51	BC198	BC146
BAY60	1N4151	BC121	BC146	BC199	BC146
BAY63	BAV10	BC122	BC146	D BC200	
BAY67	BAV10	BC123	BC146	BC201	BC200
BAY68	BAV10	BC125	BC337	BC202	BC200
BAY69	BAV10	BC126	BC338	BC203	BC200
BAY71	BAW62	BC127	2N930	BC204	BC557
BAY74	BAW62	BC129	BC547	BC205	BC558
BAY77	BAV10	BC130	BC548	BC206	BC559
BAY78	BAX12	BC131	BC109	BC207	BC547
BAY82	BAW62 BAX13	BC134	BC547	BC208	BC548
BAY86	BAX18	BC135	BC547B	BC209	BC549
BAY87	BAX12	BC136	BC547A	BC210	2N2222
BAY88	BAX16	BC137	BC327	BC211	BSX61
BAY89	BYX10	BC138	2N2219	BC212	BC556
BAY90	BYX10	BC139	2N2904	BC213	BC557
BAY91	BYX10	D BC140		BC214	BC559
BAY92	BYX10	D BC141		BC215	BC327
BAY93	BYX10	BC142	2N2218A	BC216	BC107A
BAY94	BC143	BC143	2N2905A	BC220	BC547A
BAY95	BAV10	BC144	2N2218A	BC221	BC328
BAY98	BAV20 BAX16	BC145	BF178	BC222	BC337
BAY99	BAV20 BAX16	D BC146		BC224	BC558B

type to be replaced	replacement	type to be replaced	replacement	type to be replaced	replacement
BC225	BC557	BC301	BD139	BC395	BC639
BC231	BC327	BC302	BSX59	BC396	BC640
BC232	BC337	BC303	BD140	BC397	2N2904A
M BC237	BC547	BC304	BC640	BC398	2N2218A
M BC238	BC548	M BC307	BC557	BC400	BC640
M BC239	BC549	M BC308	BC558	BC404	BC640
BC250A	BC559	M BC309	BC559	BC405	BC638
BC250B	BC559A	BC312	BC639	M BC407	BC547
BC250C	BC559B	BC315	BC557	M BC408	BC548
BC251A	BC557	BC317	BC547	M BC409	BC549
BC252A	BC558	BC318	BC548	BC413	BC550
BC252B	BC558A	BC319	BC549	BC414	BC550
BC252C	BC558B	BC321	BC558	BC415	BC560
BC253A	BC559	BC322B	BC558B	BC416	BC560
BC253B	BC559A	BC322C	BC558C	M BC417	BC557
BC253C	BC559B	BC325	BC640	M BC418	BC558
BC254	BC556	BC326	BC640	M BC419	BC559
BC255	BC337	D BC327		BC425	BC337
BC256	BC556	D BC328		BC427	BC327
BC257	BC557	D BC329	BC637	BC437	BC547
BC260	BC178	BC330	BC547	BC438	BC548
BC261	BC177	BC331	BC637	BC439	BC549
BC262A	BC178A	BC332	BC547	BC440	BC635
BC262B	BC178B	BC333	BC548	BC441	BC637
BC263A	BC179A	BC334	BC558	BC467	BC547
BC263B	BC179B	BC335	BC549	BC468	BC548
D BC264A		BC336	BC559	BC469	BC549
D BC264B		D BC337		BC477	BC640
D BC264C		D BC338		BC478	BC557
D BC264D		D BC340-6	2N2218A	BC479	BC557
BC266	BC177	BC340-10	2N2219A	BC507	BC639
BC267	BC337	BC340-16	2N2219A	BC508	BC637
BC268	BC338	BC342	BC639	BC509	BC637
BC269	BC338	BC343	BC640	BC512	BC327
BC270	BC338	BC344	BC639	BC513	BC328
BC271	BC338	BC345	BC640	BC514	BC328
BC272	BC337	BC347	BC547	D BC546	
BC280	BC107	BC348	BC548	D BC547	
BC281A	BC177	BC349	BC549	D BC548	
BC281B	BC177	BC350	BC557	D BC549	
BC281C	BC337	BC351	BC558	D BC550	
BC282	2N2483	BC352	BC558	D BC556	
BC283	2N2906	BC354	BC558	D BC557	
BC284	BC107	BC355	BC558	D BC558	
BC285	BD115	BC357	BC559	D BC559	
BC286	BD139	BC358	BC548	BC582	
BC287	BD138	BC360-6	2N2904	BC583A	
BC288	BFY55	BC360-10	2N2905	BC584	
BC289	BC107	BC360-16	2N2905	D BC635	BC548A
BC290A	BC107B	BC361-6	2N2904A	D BC636	BC549
BC291A	BC107A	BC361-10	2N2905A	D BC637	
BC291B	BC107B	D BC368		D BC638	
BC292A	BC107A	D BC369		D BC639	
BC292B	BC107B	BC381	BC328	D BC640	
BC293	BFX34	BC382	BC547	D BCW29	
BC294	BC638	BC383	BC548	D BCW30	
BC295	BC548	BC384	BC550	D BCW31	
BC297	BC327	BC389	BC547	D BCW32	
BC298	BC328	BC390	BC549	D BCW33	
BC300	BD139	BC391	BC549	BCW34	2N2222A

replacement guide for semiconductors

Code letter in front of type number indicates status of product at 1 November 1976 (page 95)

type to be replaced	replacement	type to be replaced	replacement	type to be replaced	replacement
BCW35	2N2907A	D BCY72		BD170	BD238
BCW36	2N2222A	BCY86A	BC107B	BD171	BD237
BCW37	2N2907A	BCY86B	BCY59	BD172	BD238
M BCW46	BC546	D BCY87		BD173	BD232
M BCW47	BC547	D BCY88		BD175	BD235
M BCW48	BC548	D BCY89		BD176	BD236
M BCW49	BC549	BCY90	BCY34A	BD177	BD235
M BCW56	BC556	BCY91	BCY34A	BD178	BD236
M BCW57	BC557	BCY92	BCY34A	BD179	BD237
M BCW58	BC558	BCY93	BCY30A	BD180	BD238
M BCW59	BC559	BCY94	BCY31A	D BD181	
D BCW69		BCY95	BCY32A	D BD182	
D BCW70		BCZ10	BCY33A	D BD183	
D BCW71		BCZ11	BCY34A	BD185	BD435
D BCW72		BCZ12	BCY31A	BD186	BD436
BCW85	2N2907A	BCZ13	BCY33A	BD187	BD437
BCW86	2N2907A	BCZ14	BCY34A	BD188	BD438
BCW90	BC337	BD106	BD131	BD191	BD182
BCW94	2N2222A	BD107	BD131	BD192	BD181
BCW96	2B2907A	BD109	BD131	BD195	BD201
D BCX17		BD111	BD131	BD196	BD202
D BCX18		BD113	BDY20	BD197	BD201
D BCX19		C BD115		BD198	BD202
D BCX20		BD116	BD181	BD199	BD203
D BCX51		BD117	BD182	BD200	BD204
D BCX52		BD121	BDY20	D BD201	
D BCX53		BD123	BDY20	D BD202	
D BCX54		BD124	BD131	D BD203	
D BCX55		BD127	BD232	D BD204	
D BCX56		BD128	BD232	BD205	BD201
BCY14	BFY51	BD129	BD232	BD206	BD202
BCY16	BFY51	BD130	BD182	BD207	BD203
O BCY30	BCY30A	C BD131		BD208	BD204
D BCY30A		C BD132		BD215	BD232
O BCY31	BCY31A	C BD133		BD216	BD232
D BCY31A		D BD135		D BD226	
O BCY32	BCY32A	D BD136		D BD227	
D BCY32A		D BD137		D BD228	
O BCY33	BCY33A	D BD138		D BD229	
D BCY33A		D BD139		D BD230	
O BCY34	BCY34A	D BD140		D BD231	
D BCY34A		BD142	BD182	D BD232	
O BCY38	BCY33A	BD150	BD115	D BD233	
O BCY39	BCY31A	BD151	BD234	D BD234	
O BCY40	BCY34A	BD152	BD234	D BD235	
BCY42	BCW41	BD153	BD236	D BD236	
BCY43	BCW41	BD154	BD233	D BD237	
BCY50	BCY57	BD155	BD233	D BD238	
BCY51	BCY56	BD156	BD233	C BD262	
O BCY54	BCY32A	BD157	BD232	C BD262A	
C BCY55	BCY87	BD158	BD232	C BD262B	
D BCY56		D BD160		C BD263	
D BCY57		BD161	BD235	C BD263A	
D BCY58		BD162	BD233	C BD263B	BD681
D BCY59		BD163	BD233	C BD266	BD646
BCY66	BCY59	BD165	BD233	C BD267	BD645
BCY67	BCY71	BD166	BD234	D BD291	
BCY69	BC457	BD167	BD235	D BD292	
D BCY70		BD168	BD236	D BD293	
D BCY71		BD169	BD237	D BD294	

type to be replaced	replacement	type to be replaced	replacement	type to be replaced	replacement
BD301	BD201	D BDY93		BF166	BF200
BD302	BD202	D BDY94		C BF167	BF198
BD303	BD203	D BDY95		BF168	BF173
BD304	BD204	D BDY96		BF169	BF115
BD307A	BD228	BDY11	BDY20	BF170	BF186
BD307B	BD228	BDY12	BD131	C BF173	
D BD329		BDY13	BD131	BF174	BF178
D BD330		BDY15	BD131	BF175	BF167
D BD433		BDY16	BD131	BF176	BF173
D BD434		BDY17	BD182	M BF177	BF336
D BD435		BDY18	BD183	M BF178	BF336 BF337
D BD436		BDY19	BD183	M BF179	BF337 BF338
D BD437		C BDY20		D BF180	
D BD438		BDY23	BDY20	D BF181	
BD595	BDX77	BDY24	BDY90	C BF182	
BD596	BDX78	BDY25	BD183	C BF183	
BD597	BDX77	BDY34	BD131	C BF184	
BD598	BDX78	BDY39	2N3055	C BF185	
BD599	BDX77	BDY50	BDY92	BF186	BF337
BD600	BDX78	BDY51	BDY92	BF188	BF173
D BD645		BDY53	BDY92	BF189	BF115
D BD646		BDY55	BDY20	BF191	BF196
D BD647		BDY56	BDY20	C BF194	BF494
D BD648		BDY58	BD183	C BF195	BF495
D BD649		BDY73	BDY20	C BF196	BF198
D BD650		BDY74	BD183	C BF197	BF199
D BD675		BDY77	BD183	D BF198	
D BD676		BDY78	BD183	D BF199	
BD677		BDY79	BD183	D BF200	
BD678		D BDY90		BF206	2N918
BD679		D BDY91		BF214	BF115
BD680		D BDY92		BF215	BF115
D BD681		C BDY93	BUX82	BF222	BF115
D BD682		C BDY94	BUX82	BF223	BF197
BDX10	2N3055	C BDY96	BUX80	BF224	BF173
M BDX35		C BDY97	BUX80	BF225	BF167
M BDX36		C BF115		BF230	BF195
M BDX37		BF118	BF338	BF232	BF173
D BDY62		BF119	BF337	BF233	BF495
D BDX62A		BF120	BF179	BF234	BF494
D BDX62B		BF121	BF196	BF235	BF495
D BDX63		BF123	BF197	BF237	BF115
D BDX63A		BF125	BF197	BF238	BF115
D BDX63B		BF127	BF197	D BF240	
D BDX64		BF131	BF182	D BF241	
D BDX64A		BF133	BF183	M BF244A	BF245A
D BDX64B		BF134	BF200	M BF244B	BF245B
D BDX65		BF140	BF178	M BF244C	BF245C
D BDX65A		BF152	BF183	D BF245A	
D BDX65B		BF153	BF495	D BF245B	
D BDX66		BF154	BF196	D BF245C	
D BDX66A		BF155	BF180	BF248	2N2221
D BDX66B		BF158	BF173	BF249	2N2906A
D BDX67		BF159	BF173	BF251	BF167
D BDX67A		BF160	BF495	BF252	BF167
D BDX67B		BF161	BF183	O BF254	BF494
D BDX77		BF162	BF200	O BF255	BF495
D BDX78		BF163	BF196	D BF256A	
D BDX91		BF164	BF196	D BF256B	
D BDX92		BF165	BF185	D BF256C	

replacement guide for semiconductors

Code letter in front of type number indicates status of product at 1 November 1976 (page 95).

type to be replaced	replacement	type to be replaced	replacement	type to be replaced	replacement
BF257	BF336	D BF495		BF680	BFW10
BF258	BF337	N BF622		C BF592	
BF259	BF338	N BF623		C BF593	
BF260	BF200	N BF936		C BF594	
BF261	BF196	D BFQ10		C BF595	
M BF262	BF180	D BFQ11		D BFT24	BF480
M BF263	BF181	D BFQ12		D BFT25	
M BF264	BF200	D BFQ13		BFV10	2N2221
BF268	BFY90	D BFQ14		BFV11	2N2222
BF270	BF167	D BFQ15		BFV12	2N2222A
BF271	BF173	D BFQ16		BFV20	2N2906
BF272	2N2906	D BFQ17		BFV21	2N2907
BF273	BF241	D BFQ18		BFV22	2N2907A
BF287	BF167	D BFQ19		BFV23	2N2904, 2N2905
BF288	BF167	N BFR12		BFV24	2N2904, 2N2905
BF293	BF173		BFR18	BFV63	2N2222A
BF294	BD115		BFR19	BFV64	2N2907
BF297	BF336	D BFR29		BFV67	BSX20
BF302	BF198	D BFR30		BFV69	2N918
BF303	BF199	D BFR31		BFV82	BSX19
BF304	BF196	D BFR53		BFV83	BSX19
BF305	BF337		BFR57	BFV85	2N2222
BF306	BF196		BFR58	BFV86	2N2907
BF310	BF181		BFR59	BFV87	2N2368
BF311	BF197	D BFR64		BFV88	BSX60
BF314	BF200	D BFR65		D BFW10	
BF322	2N2221	D BFR84		D BFW11	
BF323	2N2906A	D BFR90		D BFW12	
D BF324		D BFR91		D BFW13	
N BF327		D BFR92		D BFW16	BFW16A
BF334	BF240	D BFR93		D BFW16A	
BF335	BF241	D BFR94		BFW17	BFW17A
D BF336		D BFR96		C BFW17A	
D BF337		D BFS17		BFW19	2N3866
D BF338		D BFS18		BFW20	2N2907A
BF341	2N2904	D BFS19		BFW22	2N2484
BF342	BF450	D BFS20		BFW29	2N2218A
BF343	BF451	C BFS21		D BFW30	
BF357	BFY90	C BFS21A		BFW31	2N2905A
D BF362		BFS22	BFS22A	BFW32	2N2222
D BF363		D BFS22A		C BFW45	
BF364	BF494	BFS23	BFS23A	BFW47	2N3553
BF365	BF495	D BFS23A		D BFW61	
BF367	BF198	C BFS26		BFW63	BF167
BF384	BF183	BFS48	BFS93	BFW69	2N3553
BF385	BF181	BFS52	2N2904	BFW71	BFW16A
BF394	BF240	BFS53	2N2905	BFW73	BFW16A
BF395	BF241	BFS64A	2N2907A	BFW74	BFW17A
D BF422		BFS64B	2N2906	BFW75	BFW17A
D BF423		BFS65A	BSX20	BFW76	BFW17A
D BF450		BFS70	BFW13	BFW77	BFW16A
D BF451		BFS71	BFW11	BFW78	BFW17A
BF456	BF336	BFS72	2N3823	D BFW92	
D BF457	BF336	BFS73	BFW10	D BFW93	
D BF458	BF337	BFS74	2N4856	O BFW98	BLX66
D BF459	BF338	BFS75	2N4857	BFX12	2N2905A
N BF469		BFS76	2N4858	BFX13	2N2905A
N BF470		BFS77	2N4859	BFX20	BF183
D BF480		BFS78	2N4860	BFX21	BF180
D BF494		BFS79	2N4861	BFX29	2N2905A

type to be replaced	replacement	type to be replaced	replacement	type to be replaced	replacement	
	BFX30	2N2905A	BFY66	2N918	BLY74	2N3632
	BFX33	2N2218	BFY67	2N1613	O BLY76	BLX92
D	BFX34		BFY68	2N1711	BLY87	BLY87A
	BFX37	2N2907A	O BFY70	BFS23A	D BLY87A	
	BFX38	2N2905A	BFY72	2N2219	BLY88	BLY88A
	BFX39	2N2904	BFY74	2N1711	D BLY88A	
	BFX41	2N2904	BFY75	2N2222A	D BLY89A	
	BFX43	BFX89	BFY76	2N2484	D BLY90	
M	BFX44	BSX20	BFY77	2N2484	BLY91	BLY91A
	BFX48	2N2905	BFY78	BSX19	D BLY91A	
O	BFX49	BLX91	BFY79	BF173	BLY92	BLY92A
	BFX55	BFY55	BFY80	BSX21	D BLY92A	
	BFX59	BFX89	BFY85	BCY87	BLY93	BLY93A
	BFX60	BF173	BFY88	BFW17A	D BLY93A	
	BFX61	BFY55	BFY89	2N3570	D BLY94	
	BFX62	BFY90	D BFY90		BO850	BY126
	BFX63	BFR29	BFY91		D BPX25	
	BFX68	2N1711	BFY92	BCY88	D BPX29	
	BFX69	2N1613	BFY99	BCY89	D BPX40	
	BFX73	BFX89	D BG1895-541	BFW16A	D BPX41	
	BFX85	BSW66	D BG1895-641		D BPX42	
	BFX86	BFY50	N BGY37		C BPX66P	
	BFX87	2N2904A	D BLW60		D BPX70	
	BFX88	2N2904	D BLW64		D BPX71	
D	BFX89	BFX44	D BLW75		D BPX72	
	BFX94	2N2221	D BLX13		D BPX94	
	BFX95	2N2222	D BLX14		D BPX95	
	BFX96	2N2218	D BLX15		N BPW22	
	BFX97	2N2219	D BLX65		N BPW34	
	BFX98	BSW68	D BLX66		D BR101	
	BFY10	BFY50	D BLX67		BRY20	BRY39
	BFY11	BFY50	D BLX68		D BRY39	
	BFY12	BFY51	D BLX69A		D BRY39(SCS)	
	BFY13	BFY50	D BLX91		D BRY39(PUT)	
	BFY15	BFY52	D BLX92		N BSR12	
	BFY17	2N2218	D BLX93		BSS10	BSS20
	BFY18	BSW41	D BLX94A		BSS11	2N2369A
	BFY19	BCY56	D BLX95		BSS12	BSS20
	BFY27	2N2222A	D BLX96		BSS14	BFX34
	BFY33	BFY51	D BLX97		BSS19	BSS38
	BFY34	2N1613	BLY12	2N3442	BSS20	BSS38
	BFY37	BCY57	O BLY14	BLY91A	BSS26	2N2222
	BFY38	BSX21	BLY15	2N3632	D BSS38	
	BFY39	BSW41	O BLY17	BLX14	C BSS40	
	BFY40	2N2218	BLY20	2N3375	C BSS41	
	BFY41	2N2218A	BLY22	2N3632	D BSS50	
	BFY43	BSW68	O BLY33	BF323A	D BSS51	
O	BFY44	BFS23A	O BLY34	BFS22A	D BSS52	
	BFY45	BSW66	O BLY35	BLY92A	N BSS60	
	BFY46	2N2905A	O BLY36	BLY88A	N BSS61	
D	BFY50		O BLY37	BLX93	D BSS68	
D	BFY51		O BLY38	BLX67	D BSV15	
D	BFY52		O BLY53	BLX68	D BSV16	
	BFY53	BFY55	BLY57	2N3926	D BSV17	
D	BFY55	2N2297	BLY58	2N3927	D BSV52	
	BFY56	BSX61	BLY59	2N3375	BSV59	BSX59
	BFY57	BSW67	BLY60	2N3632	D BSV64	
	BFY63	2N2218	BLY61	2N3866	BSV69	BSX59
	BFY64	2N2905	BLY62	2N3927	D BSV78	
	BFY65	BF177	BLY63	BLY88A	D BSV79	

replacement guide for semiconductors

Code letter in front of type number indicates status of product at 1 November 1976 (page 95)

type to be replaced	replacement	type to be replaced	replacement	type to be replaced	replacement
D BSV80		BSX35	BSX20	BSY52	2N1711
D BSV81		BSX36	2N2907	BSY53	2N1613
BSV95	BSX59	BSX38	2N2222	BSY54	2N1711
M BSV96	BC636	BSX39	BSX20	BSY55	BSW67
M BSV97	BC638	BSX40	2N2904	BSY58	2N2218
M BSV98	BC640	BSX41	2N2905	BSY62	BSX20
BSW10	2N2218A	BSX44	BSX20	BSY63	BSX20
BSW19	BCY71	D BSX45	2N2218A	BSY68	BSX21
BSW21	BCY72	BSX46	BSW66	BSY70	BSX19
BSW22	BC177	BSX48	2N2221	BSY71	2N2219A
BSW23	2N2904	BSX49	2N2222A	BSY72	BCY57
BSW24	2N2906	BSX51	2N2222	BSY73	BCY57
BSW26	BSX59	BSX52	2N2222	BSY74	BCY57
BSW27	BSX59	BSX53	2N2222	BSY75	2N2221
BSW28	BSX59	BSX54	2N2222	BSY76	2N2222
BSW29	BSX60	D BSX59		BSY77	BSV64
BSW36	2N2907A	D BSX60		BSY78	BSX21
BSW37	2N2894	D BSX61		BSY79	BF337
O BSW41	BSW41A	BSX62	BSX59	BSY80	BCY57
D BSW41A		BSX63	BFY50	BSY81	BFY52
BSW50	2N2218	BSX66	2N2368	BSY82	2N2219
BSW51	2N2218	BSX71	BSX21	BSY83	2N2218A
BSW52	2N2219	BSX72	2N2219	BSY84	2N2219A
BSW53	2N2218A	BSX73	2N3924	BSY85	BSV64
BSW54	2N2219A	BSX74	2N2219	BSY86	BSW67
BSW60	2N2221	BSX75	BSW41	BSY87	BSW67
BSW61	2N2221	BSX78	2N2222	BSY88	BSV64
BSW62	2N2222	BSX79	BCY59	BSY90	2N2219
BSW63	2N2221A	BSX87	BSX20	BSY91	BSX60
BSW64	2N2222A	BSX88	BSX19	BSY92	2N2219A
D BSW66		BSX89	BSX19	BSY93	2N2222
D BSW67		BSX90	BSX19	BSY95	BSX20
D BSW68		BSX91	BSX20	BSY96	2N2369
M BSW69	BSS38	BSX92	2N2368	BSY99	2N929
BSW72	2N2906	BSX93	2N2369	C BT126	
BSW73	2N2907	BSX94	BSX20	M BT128	
BSW74	2N2906	BSX95	2N1711	M BT129*	
BSW75	2N2907	BSX96	2N1711	N BT138*	
BSW82	2N2221	BSX97	2N2218	N BT139	
BSW83	2N2222	BSY10	2N1613	D BTW23*	
BSW84	2N2221A	BSY11	2N930	D BTW24	
BSW85	2N2222A	BSY17	BSX19	BTW26*	BTX94
BSW88	BC147	BSY18	BSX20	M BTW30 300R	BTW30 800R
BSW89	BSX19	BSY19	BSX20	M BTW30-400R	BTW30 800R
BSW91	BSX20	BSY20	BSX19	M BTW30 500R	BTW30 800R
BSW93	BSX61	BSY21	BSX20	M BTW30-600R	BTW30 800R
BSW94	2N2894	BSY22	BSX20	D BTW30-800R	
D BSX19		BSY23	BSX20	D BTW30-1000R	
D BSX20		BSY25	2N2218	D BTW30-1200R	
D BSX21	BSS38	BSY26	BSX19	D BTW31*	
BSX22	BSX60	BSY27	BSX20	M BTW32*	
BSX23	BFX34	BSY28	BSX20	D BTW33*	
BSX24	BSW41	BSY29	BSX20	D BTW34*	
BSX25	BSW41	BSY34	BSX61	D BTW38*	
BSX26	2N2369	BSY38	BSX20	N BTW40*	
BSX27	BSX20	BSY39	BSX20	D BTW42*	
BSX28	BSX20	BSY44	2N1613	D BTW43*	
BSX30	BSX60	BSY45	BSW67	D BTW45*	
BSX32	2N2218A	BSY46	BSW67	D BTW47*	
BSX33	2N2218A	BSY51	2N2218	D BTW92*	

type to be replaced	replacement	type to be replaced	replacement	type to be replaced	replacement
D BTX18*		BY129	BY127	D BYX39*	
BTX37	BTW24*	BY130	BY126	D BYX42*	
BTX38	BTW23*	BY133	BY127	D BYX45*	
BTX47	BTW47*	BY134	BY127	D BYX46*	
BTX48	BTW92*	BY135	BY127	BYX47*	BYX35
BTX49	BTW23*	BY140	BY176	M BYX48*	BYX38* BYX98*
BTX50	BTW23*	BY144	BY176	D BYX49*	
BTX64	BTW23*	BY151	BY127	D BYX50*	
BTX65	BTW23*	BY152	BY127	M BYX52*	BYX56* BYX97*
BTX66	BTW23*	BY156	BY127	D BYX55*	
BTX81	BTW92*	BY158	BY126	C BYX56*	
BTX82	BTW24*	D BY164		BYX60/200	BAX15
D BTX94~		BY177	BY127	BYX60/400	BA145
D BTX95*		BY178	BY127	BYX62/600R	BYX30-600R
BTY79	BTW38 BTW42~	D BY179		D BYX71*	
BTY80 to 91	BTW38*	C BY184		N BYX72*	
D BTY87*	BTW38* BTW45~	D BY188		D BYX90*	
D BTY91~	BTW45~	D BY206		D BYX91*	
BTY92 to 99	BTW23 600R	D BY207		D BYX96*	
BU111	BU126	D BY208*		D BYX97*	
BU113	BU126	C BY209		D BYX98*	
D BU126		N BY223		D BYX99*	
M BU132		D BY224		BYY15	BYX97 900
D BU133		D BY225		BYY16	BYX97-900R
D BU204		D BY226		BYY21	BYX30-200R
D BU205		D BY227		BYY22	BYX96-600
D BU206		D BY277		BYY23	BYX96-600R
D BU207A		D BY409		BYY24	BYX96-600
D BU208A		D BY476		BYY25	BYX96-600R
D BU209A		N BY477		BYY31 to 37	BY127
N BU326		N BY478		BYY69 to 78	BYX96*
N BU326A		BY219	BYX38-1200	BYY88 to 92	BY127
N BUX80		BY242	BY127	BYY93 to 96	BYX32*
N BUX81		BY264	BYX36-150	BYZ10 to 19	BYZ48*
N BUX82		BY1002	BY127	BZ100	BZXB7-C10
N BUX83		D BYW19 *		BZ102-1V4	BZX75-C1V6
N BUX84		N BYW29 *		BZ102-2V1	BZX75-C2V1
N BUX85		N BYW30 *		BZ102-2V8	BZX75-C2V8
N BUX86		N BYW31 *		BZ102-3V4	BZX75-C3V6
N BUX87		N BYW54		BZ103 to 112	BZX79*
BUY16	2N3055	N BYW55		D BZV10	
BUY17	2N3055	N BYW56		D BZV11	
BUY46	BDY20	D BYX10		D BZV12	
BUY51	2N3772	M BYX13*	BYX96*	D BZV13	
BY101	BY126	BYX15	BYX97-1200	D BZV14	
BY102	BY127	BYX16	BYX97-1200R	N BZV15	
BY103	BY127	BYX20/200	BYX46-200	D BZV38	
BY104	BY127	C BYX22*		D BZW86*	
BY105	BY127	C BYX25*		D BZW91*	
BY108	BY127	BYX26	BYX36-300	D BZW93*	
BY109	BY127	BYX28/400	BYX96-600	BZX10 to 16	
BY112	BY126	M BYX30-200R	IN3891R	BZX18 to 27	BZX79*
BY113	BY127	M BYX30-300R	IN3892R	BZX29*	BZX79*
BY115	BY126	D BYX30-400R		BZX51*	BZX87*
BY116	BY126	D BYX30-500R		D BZX55*	BZX79*
BY117	BY127	D BYX30-600R		D BZX61*	
BY125	BY126	D BYX32*		BZX67*	BZX87*
C BY126		C BYX35		D BZX70*	BZY93*
C BY127		C BYX36*		BZX71*	
BY128	BY127	D BYX38*		D BZX75*	BZX79*

replacement guide for semiconductors

Code letter in front of type number indicates status of product at 1 November 1976 (page 95).

type to be replaced	replacement	type to be replaced	replacement	type to be replaced	replacement
D BZX79*		CDG00	BA100	CTP1004	BD181
D BZX84*		CDT1311	BDX96	CTP1005	BD181
D BZX87*		CDT1313	BDX96	CTP1104	BD181
D BZX90		CER68	BY126	CTP1105	BD181
D BZX91		CER69	BY126	CTP1106	BD181
D BZX92		CER72	BY127	CTP1107	BD181
D BZX93		CER720	BY127	CTP1108	BD181
BZY14 to 21	BZX79*	CG1C	OA95	CTP1109	BD181
M BZY56 to 63	BZX79*	CG1E	OA95	CTP1514	BD181
BZY64 to 69	BZX79*	CG4E	OA95	CV425	OA91
BZY74	BZZ15	CG12E	OA90	CV442	AA119
BZY75	BZY93-C7V5	CG41H	OA95	CV448	OA91
BZY76	BZY93-C9V1	CG42H	OA95	CV1353	OA91
C BZY78	BZX90	CG44H	OA95	CV1354	OA95
BZY83*	BZX79*	CG50H	OA95	CV2389	AC125
BZY85*	BZX79*	CG60H to 64H	OA90	CV2400	AC125
D BZY88*	BZX79*	CG83H	AAZ17	CV3524	BAX16
D BZY91*		CK705	OA90	CV3924	OA95
BZY92*	BZX87*	CK707	OA90	CV5063	OA95
D BZY93*		CK708	OA90	CV5209	BAV10
BZY94*	BZX79*	CK713A	OA90	CV5308	BZX79-C6V2
C BZY95*		CK790	BCY33A	CV5323	BAX16
D BZY96*		D CNY22		CV5357	BZX79-C9V1
D BZZ10	BZX79*	D CNY23		CV5378	BZX79-C5V6
BZZ11	BZX79*	D CNY42		CV5379	BZX79-C7V5
BZZ12	BZX79*	D CNY43		CV5439	BC178
BZZ13	BZX79*	D CNY44		CV5447	BC177
D BZZ14	BZX79*	D CNY46		CV5712	BC177
D BZZ15	BZX79*	D CNY47		CV5713	AC132
D BZZ16	BZX79*	D CNY47A		CV5815	BZX79-C4V7
D BZZ17	BZX79*	D CNY48		CV5816	BZX79-C6V8
D BZZ18	BZX79*	COD1538	BY127	CV5829	BZX79-C8V2
D BZZ19	BZX79*	COD1618	BY127	CV5848	BCY34A
C BZZ20	BZX79*	CP704	2N3772	CV5855	OA95
C BZZ21	BZX79*	D CQY11B		CV5864	BAX13
C BZZ22	BZX79*	D CQY24		CV5875	BDX92
C BZZ23	BZX79*	D CQY24A		CV5876	BDX96
C BZZ24	BZX79*	D CQY46		CV5930	BZX79-C12
C BZZ25	BZX79*	D CQY47		CV5953	BAV10
C BZZ26	BZX79*	D CQY49B		CV5965	BZX79-C6V2
C BZZ27	BZX79*	D CQY49C		CV7001	AC132
C BZZ28	BZX79*	D CQY50		CV7002	AC132
C BZZ29	BZX79*	D CQY52		CV7005	BC177
C11A to 11S	BTW38*	M CQY53		CV7006	AC132
C15	BA102	D CQY54		CV7008	BC179
C15G	BTW38-400R	D CQY58		CV7010	BD181
C20	BA102	N CQY59		CV7027 to 7030	BC127
C35A to 35S	BTY91*	D CQY61B		CV7040	BAX16
C36A to 36S	BTW92*	D CQY79		CV7041	OA95
C45M	BTW23-600R	D CQY81		CV7043	BCY33A
C50A to 50S	BTW23*	N CQY82		CV7044	BCY34A
C180M	BTX41-800R	N CQY85		CV7047	BAV10
C180N	BTX41-800R	N CQY88		CV7048	BAV10
C180P	BTX41-1200R	N CQY89		CV7054	BD181
C180P13	BTX41 1200R	N CQY94		CV7076	BAX13
C1780	BY127	N CQY95		CV7083	BDX96
CD000	BA100	N CQY96		CV7084	BDX92
CD00080	BA216	N CQY97		CV7085	BDX96
CD0014	BA216	CST11773	BD181	CV7086	BDX96
CD0099	BA216	CTD1104	BD181	CV7087	ASY27

type to be replaced	replacement	type to be replaced	replacement	type to be replaced	replacement
CV7099 to 7105	BZY88*	DD058	BY127	EM513	BY127
CV7113	BY127	DD236	BY126	ER41	BY126
CV7114	BY127	DD268	BY127	ER81	BY127
CV7117	BCY31A	DK13	AAZ17	ER308	BY127
CV7118	AC132	DP6	OA90	ERD800	BY127
CV7127	BAV10	DP6R	2-AA119	ESM100	BY126
CV7130	OA91	DP6C	OA90	F8	BY127
CV7141	BZY88-C4V3	DP7	OA90	F11	BY127
CV7142	BZX79-C9V1	DP10	OA90	F12	BYX38-300
CV7143	BZX79-C9V1	DR5	BZX79-C5V1	F21	BYX22-600
CV7144	BZX79-C12	DR6	BZX79-C6V2	F22	BYX38-300
CV7311 to 7320	BYX38*	DR7	BZX79-C7V5	F41	BYX22-600
CV7321	2-AC132	DR100	BY126	F42	BY127
CV7332	BAX16	DR128	BA100	F61	BY127
CV7338	BCY70	DR313	OA95	F82	BYX38-1200
CV7347	BCY34A	DR365	AA119	F100	BAX16
CV7348	2N1302	DR400	BY126	FBO50	BY164
CV7349	2N1304	DR464	OA95	FD3 to 7	AAZ18
CV7350	2N1306	DR800	BY127	FD100	BAW62 BAX13
CV7351	2N1308	DS60	OA90	FD111	BAW62 BAX13
CV7353	2N1305	DS61	OA90	FD200	BAV10 BAX16
CV7354	2N1307	DS62	OA90	FD600	BAV10
CV7355	2N1309	DS159	OA90	FD700	BAW62 BAX13
CV7363	BCY34A	DS160	OA90	FD777	BAW62 BAX13
CV7364	BAV10	DS161	OA90	FD827	BAV10
CV7369	OA91	DS604	OA90	FD828	BAW62
CV7389	BAX13	DS611	OA90	FD829	BAW62 BAX13
CV8035	OA90	DS621	OA90	FD6666	BAV10
CV8036	OA91	DS1601	OA90	FDH600	BAV10
CV8086	BAV10	DS1604	OA90	FDH666	BAW56
CV8099	BZX79-C7V5	DS1606	OA90	FDH694	BAW62 BAX13
CV8110	BYX38-600	DZ10A	BZX79-C9V1	FDN600	BAW56
CV8243	OA90	DZ12A	BZX79-C12	FDN666	BAW56
CV8332	OA90	E11	BY127	FDR300	BYX10
CV8339	BZX79-C5V1	E21	BY127	FDR600	BAV10
CV8340	BDX92	E41	BY127	FDR700	BAW62 BAX13
CV8341	BD181	E61	BY127	FM910	BYX97-600
CV8342	BDX96	E81	BY127	FST1/4	BY127
CV8356	BDX92	E101	BY127	FST2/8	BY127
CV8510	BZX79-C7V5	E107	AA119	G2	OA90
CV8992	BYX10	EA080	BY127	G2 5/9	OA95
D1B	AA119	ED3	AA119	G4/10	OA90
D1E	OA95	ED1800	AA119	G5/2	AA119
D1SA	OA95	ED1892	OA90	G5/4	OA95
D1W	AA119	ED1903	OA95	G5/5	AA119
D4	BY127	ED2102	OA90	G5/6	OA95
D6HZ	BY127	ED2848	BY127	G5/61	OA95
D8HZ	BY127	ED2911	BY127	G5/65	AA119
D15A	BY127	ED2919	BY126	G5/103	AA119
D15C	BY127	ED2923	BY127	G5/104	OA95
D18	BY126	ED3008	BY127	G5/105	AA119
D25C	BY126	EFD108	OA95	G5/161	OA95
D45C	BY126	EFD110	AA119	G6HZ	BYX39 600
D65C	BY126	EFD112	AA119	G8HZ	BYZ39 800
D85C	BY127	EM501	BY127	G26	OA90
D105C	BY127	EM502	BY127	G48	AA119
D125C	BY127	EM504	BY127	G50	OA95
D400	BY126	EM506	BY127	G51	AA119
DD006	BY126	EM508	BY127	G53	OA90
DD056	BY126	EM510	BY127	G60	OA95

replacement guide for semiconductors

Code letter in front of type number indicates
status of product at 1 November 1976 (page 95)

type to be replaced	replacement	type to be replaced	replacement	type to be replaced	replacement
G63	OA95	GD242D	<i>BD434</i>	HG5087	AAZ17
G65	OA95	GEX12	OA90	HG5095	AAZ15
G66	OA95	GEX13	OA95	HG5808	AAZ17
G67	OA95	GEX23	OA95	HJ35	BDX92
G68	OA95	GEX24	OA95	HMG789	BAV20 BAX16
G69	OA95	GEX34	AA119	HMG3593	BA100 BAV18
G296	BA148	GEX35	AA119	HMN3593	BAV20 BAX16
G498	AAZ17	GEX36	OA90	HMR3593	BAV20 BAX16
G510	OA95	GEX37	OA95	HMS3593	BAV20 BAX16
G580	AAZ18	GEX39	OA90	HS101	BAV20 BAX16
G603	AA119	GEX44	OA95	HS1004	BAV20 BAX16
G1010(R)	BYX42 300(R)	GEX45	OA95	HS1005	BAV20 BAX16
G2010(R)	BYX42 300(R)	GEX45 1	OA95	HS1006	BAV20 BAX16
G3010(R)	BYX42 600(R)	GEX45 2	OA95	HS1007	BAV20 BAX16
G4010(R)	BYX42 900(R)	GEX54	OA95	HS1008	BAV20 BAX16
G5010(R)	BYX42 900(R)	GEX58	OA95	HS1009	BAV20 BAX16
G6010(R)	BYX42 900(R)	GEX61	OA95	HS1010	BAV20 BAX16
GA1	OA95	GEX66	AA119	HS1011	BAV20 BAX16
GA100	AA119	GEX71	<i>AAZ18</i>	HS1012	BAV20 BAX16
GA101	AA119	GEX941	<i>AAZ15</i>	HS1395	BAV20 BAX16
GA104	OA95	GEX942	<i>AAZ15</i>	HS2043	BZX88 C4V3
GD1E	OA95	GEX943	<i>AAZ15</i>	HS2047	BZX79 V4V7
GD1P	2 AA119	GEX944	<i>AAZ15</i>	HS2051	BZX79 C5V1
GD1Q	OA95	GEX945	<i>AAZ15</i>	HS2056	BZX79 C5V6
GD2E	OA95	GEX946	<i>AAZ15</i>	HS2062	BZX79 V6V2
GD20	OA95	GEX951	<i>AAZ18</i>	HS2068	BZX79 C6V8
GD3	OA90	GEX952	<i>AAZ18</i>	HS2075	BZX79 C7V5
GD3E	OA95	GR1	BYX50 200	HS2082	BZX79 C8V2
GD3 71	AAZ15	GR2	BYX50 300	HS2085	BZX79 C8V2
GD4	AA119	GR2010	IN3891	HS2091	BZX79 C9V1
GD4E	OA95	GR3010	IN3892	HS2120	BZX79 C12
GD4S	OA95	GR4010	BYX30 400	ITT600	BAV62
GD5	AA119	GSD2	OA95	IWP	BY127
GD5E	OA95	GSD2 5 9	OA91	JCN1	BY126
GD6	OA90	GSD4 10	OA95	JCN2	BY126
GD6E	AA119	GSD4 12	OA95	JCN4	BY126
GD8	OA95	GSD5 6	OA95	JCN7	BY127
GD8E	AAZ15	GSD5 61	OA95	K2 5 9	OA95
GD8F	AAZ15	GSD5 62	OA95	K4 10	BYX97 600
GD11E	OA95	GSD9	OA95	K5 4	BYX97 600
GD12	OA90	GX54	OA95	K5 5	BYX97 600
GD12E	OA90	GZ10A	BZZ20	K5 6	BYX97 1200
GD13E	AA119	GZ12A	BZZ22	K5 61	BYX97 1200
GD71	OA90	GZ15A	BZZ24	K5 62	BYX97 1200
GD71E	OA90	GZ18A	BZZ26	K5 161	BZY93
GD71E2	OA90	GZ22A	BZZ28	K540	BZX79 C6V2
GD71E3	OA90	H2	<i>BD181</i>	K1040	BZX79 C6V8
GD71E4	OA90	H3	<i>BD181</i>	K2040	BZX79 C6V2
GD71E5	OA90	H4	<i>BD181</i>	K3040	BZX79 C7V5
GD72	AA119	HD16A	OA90	K4040	BZX79 C8V2
GD72E	AA119	HD2053	OA95	K5040	BYX97 1200
GD72E3	OA90	HD2057	OA95	K6040	BYX97 1200
GD72E4	OA90	HD2060	OA95	KR50 to 58	BZY93
GD72E5	OA90	HD2063	OA95	KS37A	BZX79 C6V2
GD73E	AA119	HD6005	OA200	KS38A	BZX79 C6V8
GD73E4	AA119	HDS395	BA100	KSB38B	BZX79 C6V2
GD73E5	AA119	HE3593	BA100	KS39A	BZX79 C7V5
GD242A	<i>BD434</i>	HG1005	OA95	KS40A	BZX79 C8V2
GD242B	<i>BD434</i>	HG1012	OA90	KS40B	<i>BZX79-C7V5</i>
GD242C	<i>BD434</i>	HG5008	AAZ17	KSKE125C 500	BY127

type to be replaced	replacement	type to be replaced	replacement	type to be replaced	replacement
LT5093	BDX96	MJ1001	BDX63A	MZ33A	BZX79 C33
M0	<i>BA</i> X12	MJ1800	<i>BD</i> Y98	MZ39A	BZX79 C39
M4HZ	BY127	MJ2500	BDX64	MZ500 9	BZX79 C5V1
M8HZ	BY127	MJ2501	BDX64A	MZ500-11	BZX79 C6V2
M12	BY126	MJ3000	BDX65	MZ1016	BZX79 C16
M14	BAX15	MJ3001	BDX65A	MZ4615	<i>BZ</i> X75 C2V1
M22	<i>BA</i> V21	MJ3029	<i>BD</i> Y95	MZ4616	<i>BZ</i> X75 C2V1
M24	<i>BA</i> 148	MJ3030	<i>BU</i> 133	MZ4618	<i>BZ</i> X75 C2V8
M34	<i>BA</i> 148	MJ4030	BDX66	MZ4619	<i>BZ</i> X75 C2V8
M42	BYX10	MJ4031	BDX66A	MZ4620	BZY88 C3V3
M44	<i>BY</i> X10	MJ4032	BDX66B	MZ4621 to 4627	BZY 88
M62	BY126	MJ4033	BDZ67	MZ292	BZY96
M64	<i>BY</i> 126	MJ4034	BDX67A	NA85	BY127
M69	<i>BY</i> X48 300	MJ4035	BDX67B	NS662	BC177
M70	<i>BY</i> X48 600	MJE101	<i>BD</i> 132	NU34	OA95
M72D	BY127	MJE105	<i>BD</i> 132	NU38	OA95
M82	<i>BY</i> X10	MJE201	<i>BD</i> 131	NU58	OA95
M84	<i>BY</i> X10	MJE205	<i>BD</i> 131	NV34	OA95
M102	BY127	MM4	BY126	NV38	OA95
M104	<i>BY</i> X10	MM1549	BLX92	NV58	OA95
M550	OA91	MM1550	BLX93	OA5	AAZ15
M550A	OA95	MM1551	BLX94	OA7	AAZ17
M550B	OA95	MM1557	BLY91A	OA9	AAZ18
M720B	BY127	MM1558	BLY92A	OA10	AAZ17
M820	OA91	MM1559	BLY93A	OA21	OA90
M1230	OA91	MM1601	BLY87A	OA45	BAV10
M3100	OA95	MMR6 4	BDX96	D OA47	AAZ17
M6100	OA91	MMR6 6	BDX96	OA48	BAV10
M34A	OA95	MMR6 12	<i>BD</i> 181	OA49	BAV10
M38A	OA95	MN24	<i>BD</i> 181	OA50 to 61	OA95
M52	AA119	MN25	<i>BD</i> 181	OA65	OA95
M51 1N51	AA119	MN26	<i>BD</i> 181	OA70	OA90
M54A	OA95	MPS6513	BC547	OA71	OA95
M54A 1N54C	BAW62 1N4148	MPS6514	BC548	OA72	AA119
M56 1N56	BAV10	MPS U01	<i>BD</i> 137	OA73	OA90
M81 1N81	OA95	MPS U05	<i>BD</i> 137	OA74	OA95
M95 1N95	1N4148	MPS U06	<i>BD</i> 139	OA79	AA119
M102	BY127	MPS U51	<i>BD</i> 138	OA80	OA91
MA23A	AA119	MR31	BA145	OA81	OA95
MA23B	AA119	MSS1000	<i>BA</i> 216 <i>BA</i> 316	OA85	OA90
MA23C	AA119	MSS1001	<i>BA</i> 216 <i>BA</i> 316	OA86	OA95
MA51	AA119	MT14	BY127	OA87	OA95
MA51A	AA119	MT21	BY127	D OA90	
MA125	BY126	MT24	BY126	D OA91	OA95
MA215	BY127	MT44	BY127	OA92	OA95
MA4060D	BYX35	MT64	BY127	D OA95	
MC19	BAV20	MT84	BY127	OA96	BAW62
MC22	BAX12	MT1060	2N3570	OA100 30	OA95
MC140	BD135	MTC70	AC132	OA126	BZX79 C4V7
MC150	BD136	MTC71	AC126	OA126 4	BZX88 C3V9
MC800	BD135	MTC72	AC132	OA126 5 to 126-12	BZX79
MC810	BD137	MTC76	AC128	OA126 14	BZX79 C15
MC900	BD136	MZ5A	BZX79 C5V6	OA126 18	BZX79 C18
MC910	BD136	MZ6K	BZX79 C6V2	OA127	AAZ18
MC2396	BA100	MZ8A	BZX79 C8V2	OA128	AAZ17
MEU22	BDY96	MZ10A	BZX79 C10	OA129	AAZ17
MHT4515	2N3553	MZ12A	BZX79 C12	OA130	AAZ15
MJ900	BDX62	MZ15A	BZX79 C15	OA150	OA95
MJ901	BDX62A	MZ18A	BZX79 C18	OA159	AA119
MJ1000	BDX63	MZ22A	BZX79 C22	OA160	OA90

replacement guide for semiconductors

Code letter in front of type number indicates status of product at 1 November 1976 (page 95).

type to be replaced	replacement	type to be replaced	replacement	type to be replaced	replacement
OA161	OA95	OC75	AC126	D OSM9310	
OA172	2-AA119	OC78	AC128	D OSM9410	
OA174	OA95	OC79	AC132	D OSS9110	
OA179	AA119	OC80	AC126	D OSS9210	
OA180	AAZ17	OC81 to 85	AC128	D OSS9310	
OA182	AAZ15	OC110	AC125	D OSS9410	
OA186	BAW62	OC120	AC125	OX3003	AC125
OA199	AA119	OC122	AC126	OX3004	AC132
M OA200	BAV18	OC123	AC125	OY100	BY127
M OA202	BAV20	OC130	AC125	OY101	BY127
OA204	BAV18	OC202	ASY27	OY241	BY127
OA210 to 213	BYX38*	OC203	BCY34A	OY252 to 257	BY127
OA214	BY127	OC302	AC128	OY312 to 317	BY127
OA215	BYX38-600	OC303	AC125	OY5061 to 5067	BY127
OA216	BYX38-300	OC304	AC125	P6	BY127
OA250	BYX97 600	OC304-1	AC125	P6HZ	BYX96-1000R
OA251	BYX97-600	OC304-2	AC125	P6RPF8	BY127
OA252	BYX97 600	OC304-3	AC125	P100	BY126
OA257	OA90	OC305-N	AC125	PA340	BY126
OA258	OA90	OC305-1	AC126	PH1108	BY127
OA260	BYX97-600	OC305-2	AC126	PH1012	BY127
OA261	OA95	OC306-1	AC125	PH1021	BY126
OA265	OA95	OC306-2	AC125	PS125	BY126
OA266	OA95	OC306-3	AC125	PS140	BY126
OAZ200 to 227	BZX79	OC308	AC128	PS2247	BY126
OAZ208	BZY88C 4V3	OC310	AC128	PT1558	2N3553
OAZ222	BZX87 C5V6	OC318	AC128	PT4416	BD181
OAZ224	BZX87-C6V8	OC364	BC179	Q6	AC132
OAZ228	BZY93-C10	OC400	ASY27	Q7	AC132
OAZ230	BZY93-C12	OC410	ASY27	Q8	AC132
OAZ240 to 247	BZY79	OC601	AC125	QZ5-6	BZX79-C5V6
OAZ268	BZY88C C4V3	OC602	AC125	RD13B	BZX87 C12
OAZ269	BZY79-C5V1	OC602S	AC132	RL31	OA95
OAZ270 to 273	BZY79	OC603	AC126	RL31G	AA119
OAZ291	BZY93 C7V5	OC604	AC126	RL32	OA95
OAZ292	BZY93-C9V1	OC604S	AC128	RL32G	AA119
OC13	AC125	OC701	BCY31	RL33	AA119
OC14	AC126	OC810	AC125	RL33D	AA119
OC19	BD181	OC811	AC125	RL34	OA95
OC22 to 27	BD181	OC6015	AC125	RL34G	OA95
OC28	BDX96	OD603	BD181	RL41	OA90
OC29	BDX92	OD150	BD181	RL41G	OA90
OC30	BD181	OD604	BD181	RL43	OA95
OC33	AC125	OD605	BD181	RL43G	OA95
OC34	AC125	D ORP10		RL44	OA95
OC35	BDX92	D ORP13		RL44G	OA95
OC36	BDX96	D ORP60		RL49	OA90
OC38	AC132	D ORP61		RL52	AA119
OC41	ASY27	D ORP62		RL143	OA95
OC42	ASY27	D ORP66		RL231	OA95
OC43	ASY27	D ORP68		RL232	AA119
OC46	ASY26	D ORP69		RL329	AA119
OC47	ASY27	OS34	BAV20	RL349	OA90
OC65	AC125	OS35	BAV20	RL419	OA90
OC66	AC126	D OSB9110		RL439	OA95
OC70	AC125	D OSB9210		RL449	OA95
OC71	AC125	D OSB9310		RN6015	BYX25-1000
OC72	AC132	D OSB9410		D RPY58A	
OC73	AC125	D OSM9110		D RPY71	
OC74	AC128	D OSM9210		D RPY76A	

type to be replaced	replacement	type to be replaced	replacement	type to be replaced	replacement
C RPY82		SFD119	BAV10	SX635	BY127
C RPY84		SFD121	AAZ18	SX638	BY127
C RPY85		SFD122	AAZ17	SX641	BAV10
S2AR1	BY127	SFD125	AAZ15	SX761	BZY91-C33
S2E20	BY126	SFD127	AAZ17	SZ6	BZX79-C6V2
S16	BY126	SFD129	AAZ18	SZ7	BZX79-C6V8
S20	BY127	SFD132	AAZ17	SZ8	BZX79-C8V2
S21 to 24	BAX16	SFD135	AAZ15	SZ9	BZX79-C9V1
S28	BY127	SFD180	BAV20 BAX16	T12G	AAZ17
S32 to 35	BAV20 BAX16	SFD181	BAV20 BAX16	T13G	AAZ17
S63	BY127	SFD182	AA119	T14G	AAZ17
S235	BY126	SFR125	AAZ15	T21G	AA119
S243	BY126	SFR150	BY126	TCR42C	BTX18-100
S258	BY127	SFR151	BY126	TF1	BYX36-150
S407	BA100 BAV18	SFR152	BY126	TF2	BYX36-150
S555G	BAW62	SFR153	BY127	TF5	BAW62
SA131	AC128	SFR154	BY126	TF6	1N914
SAY30	BAV18 BAX16	SFR251	BY126	TF7	BAW62
SAY32	BAV18 BAX16	SFR252	BY126	TF11	BA100
SAY40	AA119	SFR254	BY126	TF20	BAX16
SAY42	BAV18 BAX16	SFR255	BY127	TF21	BAX15
SC8	BY127	SFR256	BY127	TF22	OA202
SCE1	BY126	SFR264	BY127	TF23	BA145
SCE4	BY126	SFR266	BY127	TF44	BAX13
SCE6	BY127	SFR268	BY127	TF49	ASY27
SD1	BY126	SH1	BY126	TF51	BAV10
SD1B	BY127	SI01	BY127	TF75	BAW62 1N4448
SD2	BY127	SI03	BY127	TF77/60	BDX96
SD5	BAV20 BAX16	SI5065	BY127	TF78	AD181
SD6	BY127	SK5/02	BY126	TF78/30	BD434
SD7	BAX16	SK3009	BD181	TF78/60	BD434
SD8	BY127	SK3012	BD181	TF80	AD181
SD15	BAX16	SK3014	BD181	TF80/30	AD181
SD30	BAX16	SK3016	BY126	TF80/60	BDX96
SD34	OA95	SK3017	BY127	TF80/80	BDX96
SD38	OA95	SK3024	BD137	TF85	AD181
SD46	AA119	SK3027	2N3055	TF90	AD181
SD50	BAX16	SLA560	BY127	TF90/30	AD181
SD54	OA95	SLA604	BY126	TF90/60	AD181
SD60	OA90	SLA2616	BY127	TF227	BA100
SD80	BAX16	SLA3196	BY127	THP45	AD181
SD92	BY127	SM280	BY127	THP46	AD181
SG94	BY127	SR500	BY127	THP47	BDX92
SD96	BY127	SR500B	BY127	THP50	AD181
SD220	BAX16	SR1692	BY126	THP51	AD181
SD925	BY126	SR4201	BY127	THP52	AD181
SE05A	BY127	SV9	BZX79-C9V1	T1156	AD181
SE32	BA148	SV124	BZX79 C5V6	T1158	AD181
SFD010	AA119	SV128	BZX79-C8V2	T1160	AD181
SFD021	AAZ17	SV134	BZX79-C12	T1484	BFY55
SFD037	AAZ17	SW05	BY127	T1539	AD181
SFD083	BA217	SW05A	BY127	T1540	AD181
SFD104	OA90	SW05B	BY127	T13027	BDX92
SFD106	OA90	SW05C	BY127	T13028	BDX96
SFD107	AA119	SW05S	BY127	T13031	BDX96
SFD108	OA95	SX561	BAV10	TIP29A	BD137
SFD110	AA119	SX631	BY126	TIP30	BD138
SFD112	AA119	SX632	BY127	TIP31	BD131
SFD113	AA119	SX633	BY127	TIP32	BD132
SFD115	AA119	SX634	BY126	TIP45	BSX19

replacement guide for semiconductors

Code letter in front of type number indicates status of product at 1 November 1976 (page 95)

type to be replaced	replacement	type to be replaced	replacement	type to be replaced	replacement
TIP62	BC547	Z4XL18B	BZX61 C18	ZG3 9	BZY88 C3V9
TIP115	BD678	Z5	BZX79-C5V6	ZG4 7	BZX79 C4V7
TIP140	BDX67	Z5K	BZX79-C5V6	ZG5 6	BZX79 C5V6
TIP141	BDX67A	Z6	BZX79-C6V2	ZG6 8	BZX79 C6V8
TIP142	BDX67B	Z6K	BZX79 C6V2	ZG8 2	BZX79 C8V2
TIP145A	BDX66	Z6 2	BZX79 C6V2	ZG10	BZX79 C10
TIP146A	BDX66A	Z6 8	BZX79 C6V8	ZG12	BZX79 C12
TIP147A	BDX66B	Z7	BZX79 C7V5	ZG15	BZX79 C15
TJN300 2	BD181	Z7K	BZX79 C7V5	ZG18	BZX79 C18
TJN300 2A	BD181	Z8	BZX79 C8V2	ZG22	BZX79 C22
TKF80	BY127	Z8K	BZX79-C8V2	ZG27	BZX79 C27
TM56	BY126	Z9 1	BZX79-C9V1	ZL3 9	BZY88 C3V9
TM62	BY127	Z10	BZX79 C10	ZL4 7	BZY96 C4V7
TM86	BY127	Z11	BZX79 C11	ZL5	BZY96 C5V6
TP5006	BTW38-600R	Z12	BZX79 C12	ZL5 6	BZY96 C5V6
TP6006	BTW38-600R	Z12K	BZX79 C12	ZL6	BZY96 C6V8
TP7006	BTW38*	Z15	BZX79 C15	ZL6 8	BZY96 C6V8
TP8006	BTW38 800R	Z15K	BZX79 C15	ZL7	BZY96-C7V5
TR7015	BTW45* BTW47*	Z18	BZX79 C18	ZL8	BZY96 C8V2
TS1	BY126	Z18K	BZX79 C18	ZL8 2	BZX61 C8V2 BZX87 C8V2
TS2	BY126	Z22	BZX79 C22	ZL10	BZX61 C10 BZX87 C10
TS4	BY126	Z22K	BZX79 C22	ZL12	BZX61 C12 BZX87 C 2
TS176	BD181	ZA10	BZX61 C10	ZL15	BZX61 C15 BZX87 C15
TSW5010B	BTW23 600R	ZA68	BZX61 C68	ZL18	BZX61 C18 BZX87 C18
TSW5020B	BTW23 600R	ZE1V5	BZX75 C1V4	ZL22	BZX61 C22 BZX87 C22
TSW5030B	BTW23 600R	ZE2	BZX79 C2V1	ZL27	BZX61 C27 BZX87 C27
TSW5040B	BTW23 600R	ZE6V9	BZX79 C6V8	ZL33	BZX61 C33 BZX87 C33
TSW5050B	BTW23 600R	ZE9V4	BZX79-C9V1	ZL39	BZX61 C39 BZX87 C39
TSW5060B	BTW23 600R	ZE12V7	BZX79 C13	ZL47	BZX61 C47 BZX87 C47
TSW7010B	BTW23 600R	ZE17V2	BZX79-C18	ZL56	BZX61 C56 BZX87 C56
TSW7020B	BTW23 600R	ZE23V2	BZX79 C24	ZL68	BZX61 C68 BZX87 C68
TSW7030B	BTW23 600R	ZE31V	BZX79 C30	ZM4 7	BZY96 C4V7
TSW7040B	BTW23 600R	ZF2 7	BZX75 C2V8	ZM5 6	BZX79 C5V6
TSW7050B	BTW23 600R	ZF3	BZX75 C2V8	ZM6 8	BZX79 C6V8
TSW7060B	BTW23 600R	ZF3 3	BZY88 C3V3	ZM8 2	BZX61 C8V2 BZX87 C8V2
UT227	BY127	ZF3 6	BZY88 C3V6	ZM10	BZX61 C10 BZX87 C10
UT3005	BYX49 300	ZF3 9	BZY88 C3V9	ZM12	BZX61 C12 BZX87 C12
VD11	OA90	ZF4 3	BZY88 C4V3	ZM15	BZX61 C15 BZX87 C15
VD12	OA90	ZF4 7	BZY79 C4V7	ZM18	BZX61 C18 BZX87 C18
VD13	OA90	ZF5 1	BZX79 C5V1	ZM22	BZX61 C22 BZX87 C22
V15 10DP	BD181	ZF5 6	BZX79 C5V6	ZM27	BZX61 C27 BZX87 C27
V15 10P	BD181	ZF6 2	BZX79 C6V2	ZM33	BZX61 C33 BZX87 C33
V15 20P	BD181	ZF6 8	BZX79 C6V8	ZM39	BZX61 C39 BZX87 C39
V30 20P	BD181	ZF7 5	BZX79 C7V5	ZM47	BZX61 C47 BZX87 C47
V30 30P	BD181	ZF8 2	BZX79 C8V2	ZM56	BZX61 C56 BZX87 C56
V208	BD181	ZF9 1	BZX79 C9V1	ZM68	BZX61 C68 BZX87 C68
V308	BD181	ZF9 10	BZX79 C10	郑2 7	BZX75 C2V8
X6	BZX79 CV2	ZF11	BZX79 C11	郑3	BZX75 C2V8
XU604	BY127	ZF12	BZX79 C12	郑3 3	BZY88 C3V3
WX1	OA95	ZF13	BZX79 C13	郑3 6	BZY88 C3V6
Z2A51F	BZY96-C5V1	ZF15	BZX79 C15	郑3 9	BZY88 C3V9
Z2A56F	BZY96 C5V6	ZF16	BZX79 C16	郑4 3	BZX79 C4V3
Z2A62F	BZY96-C6V2	ZF18	BZX79 C18	郑4 7	BZY88 C4V7
Z2A82F	BZY96 C8V2	ZF20	BZX79 C20	郑5 6	BZX79 C5V6
Z2A75F	BZY96 C7V5	ZF22	BZX79 C22	郑6 2	BZX79 C6V2
Z3	BZY88 C3V6	ZF24	BZA C24	郑6 8	BZX79 C6V8
Z3K	BZY88 C4V3	ZF27	BZX79 C27	郑7 5	BZX79 C7V5
Z4	BZX79-C4C7	ZF30	BZX79 C30	郑8 2	BZX79 C8V2
Z4K	BZX79-C4V7	ZF33	BZX79 C33	郑9 1	BZX79 C9V1
Z4B20	BZX61 C20	ZG3 3	BZY88 C3V3	郑10	BZX79 C10

type to be replaced	replacement	type to be replaced	replacement	type to be replaced	replacement
ZP11	BZX79-C11	0501	BAV20 BAX16	1N137	BAV20 BAX16
ZP12	BZX79-C12	0502	BA145	1N138A	BAV20 BAX16
ZP13	BZX79-C13	0504	BYX70	1N138B	BAV20 BAX16
ZP15	BZX79-C15	0507	BYX70	1N141	OA95
ZP16	BZX79-C16	1G27	OA95	1N142	OA95
ZP18	BZX79-C18	1G86	OA95	1N153	BY127
ZP20	BZX79-C20	1G91	OA90	1N175	OA95
ZP22	BZX79-C22	1G92	OA90	1N191	BAW62 1N4148
ZP24	BZX79-C24	1G95	AA119	1N192	BAW62 1N4148
ZP27	BZX79-C27	1HT180	BY179	1N194A	BAV18
ZP30	BZX79-C30	1HY100	BY127	1N198	OA95
ZP33	BZX79 C33	1N27	OA95	1N200 to 211	BAV20 BAX16
ZS8	BAW62	1N28A	OA95	1N215	BAV20 BAX16
ZS10	AA119	1N30	OA95	1N216	BAV20 BAX16
ZS12	BZX79 C12	1N32A	OA95	1N220	BA145
ZS22A	BZX61 C22	1N34	OA95	1N225	BZX79 C9V1
ZS40	AA119	1N35	AA119	1N248A	BYX97 600
ZS41	BAW62	1N36	AA119	1N248B	BYX97 600
ZS47	BZX79-C47	1N38	OA95	1N249A	BYX42 300
ZS91	BAX16	1N39A	OA95	1N249B	BYX97 600
ZS141	BAX62	1N40	AA119	1N250A	BYX97-600
ZS142	BAW62	1N42	OA95	1N250B	BYX97-600
ZT20	BZX61 C20 BAX87 C20	1N43	OA95	1N251	BAV20 BAX16
ZT22	BZX61-C22 BZX87 C22	1N44	OA95	1N252	BAV20 BAX16
ZT1708	BSX19	1N42 to 45	OA95	1N253	BY126
ZTX311	BSX19	1N46	BAW62 1N4148	1N254	BY126
ZTX342	BSS38	1N47 to 52	OA95	1N255	BY126
ZX5 6	BZX79-C5V6	1N54	OA95	1N256	BY127
ZX6 2	BZX79-C6V2	1N56	OA95	1N265	OA95
ZX6 8	BZX87 C6V8	1N57	OA95	1N266	OA95
ZX7 5	BZX79-C7V5	1N58	OA95	1N267	AA119
ZX8 2	BZX79-C8V2	1N60	AA119	1N270	OA95
ZX9 1	BZX79-C9V1	1N61	OA95	1N276	AAZ15
ZX10	BZX79-C10	1N62	OA95	1N277	AAZ15
ZX11	BZX79-C11	1N63	OA95	1N279	AAZ15
ZX12	BZX79-C12	1N64	AA119	1N281	AAZ15
ZX13	BZX79-C13	1N65 to 71	OA95	1N283	AAZ18
ZX15	BZX79-C15	1N74	OA95	1N290	OA95
ZX16	BZX79-C16	1N75	OA95	1N292	BAV10
ZX18	BZX79 C18	1N81	OA95	1N294	OA95
ZX20	BZX79-C20	1N82	OA95	1N295(A)	AA119
ZX22	BZX79-C22	1N84	OA95	1N297	OA95
ZX24	BZX79-C24	1N86	OA95	1N298	OA95
ZX27	BZX79-C27	1N87	AA119	1N300A	BAV20 BAX16
ZX30	BZX79-C30	1N88	OA95	1N301	BAV18
ZX33	BZX79-C33	1N89	OA95	1N303	BAX16
ZX36	BZX79-C36	1N90	OA95	1N310	BYX36-150
ZX39	BZX79-C39	1N91	BY126	1N313	OA95
ZX43	BZX79-C43	1N92	BY126	1N314	AAZ15
ZX47	BZX79-C47	1N93	BY126	1N319	AA119
ZX51	BZX79-C51	1N95 to 100	OA95	1N330	BAV20 BAX16
ZX56	BZX79-C56	1N105	OA90	1N332	BY126
ZX62	BZY95-C62	1N111 to 118	OA95	1N333	BY126
ZX68	BZY95-C68	1N119	BAW62 1N4148	1N338 to 349	BY126
0100	BAX12	1N120	BAW62 1N4148	1N350	BA100
0101	BAV20 BAX16	1N126(A)	OA95	1N351	BAV20 BAX16
0111	BAV20 BAX16	1N127(A)	OA95	1N352	BA148
0307	BY127	1N128(A)	OA95	1N355	OA95
0327	BY127	1N132	AA119	1N380	BA100
0500	BAX18	1N135	OA95	1N385	BAV20 BAX16

replacement guide for semiconductors

Code letter in front of type number indicates status of product at 1 November 1976 (page 95).

type to be replaced	replacement	type to be replaced	replacement	type to be replaced	replacement
1N386	BAV20 BAX16	1N676	BAX16	1N1195 to 1198A	BYX96*
1N424	BAV20 BAX16	1N678	BAV21	1N1202A	BYX40-600
1N429	BZX79-C6V2	1N683	BY126	1N1206A	BYX42-600
1N432	BAV20 BAX16	1N687	BY127	1N1217	BYX38-300
1N433	BAV20 BAX16	1N695	AAZ15	1N1255	BY127
1N434	BAV20 BAX16	1N696	BAW62 BAX13	1N1259	BY127
1N441 to 445	BY126	1N697	BAX12	1N1342	BYX38-300
1N448	OA95	1N698	BAW62 BAX13	1N1343A	BYX48-300
1N456A	BAW62	1N702	BZX75-C2V8	1N1348	BYX42-600
1N457	BAV20 BAX16	1N703	BZY88-C3V6	1N1443	BYX38-1200
1N457M	BAV18	1N704	BZY88-C4V3	1N1486	BY127
1N458	BAV20 BAX16	1N706 to 735	BZX79	1N1492	BY127
1N459	BAV21 BAX17	1N746	BZY88-C3V3	1N1520	BZZ14
1N460	BA216 BA316	1N747	BZX75-C3V6	1N1521	BZX61 C6V8
1N461 to 464	BAV20 BAX16	1N748	BZY88-C3V9	1N1523	BZX61 C10 BZX87 C11
1N468	BZY88-C4V3	1N749	BZY88-C4V3	1N1581 to 1587	BYX61 BZX87
1N470	BZY79-C6V8	1N750 to 767	BZX79	1N1612 to 1615	BZX61 BZX87
1N476 to 480	OA95	1N769	BZX79-C22	1N1621	BYX42-300
1N482	BAV20 BAX16	1N781(A)	AA119	1N1624	BYX42-600
1N483	BAV20 BAX16	1N789(M)	BAV18	1N1649	BY126
1N484	BAV20 BAX16	1N811	BAV20 BAX16	1N1671	BY127
1N485	BAV21 BAX17	1N813M	BAV20 BAX16	1N1692 to 1696	BY126
1N486(A)	BA148	D 1N821		1N1697	BY127
1N487(A)	BA148	D 1N823		1N1763	BY126
1N488(A)	BA148	D 1N825		1N1816(A) to 1834(A)	BZY93
1N501	AAZ15	D 1N827		1N2024B	BYX42 400
1N520	BA216 BA316	N 1N829		1N2035 to 2038	BZX61 BZX87
1N527	AA119	1N837A	BAV20 BAX16	1N2069(A)	BY126
1N536	BY126	1N846	BAV10	1N2070(A)	BY127
1N537 to 540	BY127	1N854	BY127	1N2071(A)	BY127
1N541	AA119	1N900	BA219 BAV19	1N2160	BYX97 1200
1N542	2-AA119	1N903A	1N4150 BAV10	1N2222	BY127
1N547	BY127	1N904	BAV10	1N2482	BY126
1N560	BY127	C 1N914		1N2483	BY126
1N562	BY127	C 1N914A		1N2484	BY127
1N570	BY127	1N915	BAV10	1N2505	BY126
1N573	BY127	C 1N916		1N2545B	BYX38 1200
1N597	BYX10	C 1N916A		1N2609 to 2617	BY126
1N599A	BY126	C 1N916B		1N2765	BZX79-C6V8
1N600A	BY126	1N917	BAV10	1N2773	BY127
1N602A to 606A	BY126	1N930	BA100 BAV18	1N2808	BZY91 C11
1N615	OA90	1N937	BZX79-C9V1	1N2809	BZY91 C11
1N616	OA90	1N941	BZX79-C12	1N2860	BY126
1N617	OA95	1N942	BZX79-C12	1N2862	BY126
1N618	OA95	1N957 to 982	BZX79	1N2970 to 3002	BZY93
1N625	BAW62 BAX13	1N995	AAZ18	1N3016 to 3042	BZX61 BZX87
1N636	OA95	1N997	BAV18	1N3062	BAV10
1N643	BAV20 BAX16	1N1046	BY126	1N3063	BAV10
1N645	BY126	1N1052	BYX71 350	1N3064	BAV10
1N646	BY126	1N1084	BY126	1N3065	1N4151
1N647	BY126	1N1092	BYX38-600	1N3066	BAW62 BAX13
1N648	BY127	1N1095	BY126	1N3067	BAW62 BAX13
1N649	BY127	1N1096	BY127	1N3068	BAW62 BAX13
1N658	BAV20 BAX16	1N1097	BYX10	1N3069	BAV10
1N659	BAV20 BAX16	1N1103	BY127	1N3070	BAV20 BAX16
1N660	BAV20 BAX16	1N1115 to 1120	BYX38	1N3071	BAX17
1N661(A)	BAV21 BAX17	1N1124	BYX48-300	1N3121	AAZ17
1N662	BAV20 BAX16	1N1169	BY127	1N3122	AAZ18
1N663	BAV20 BAX16	1N1191A	BX147 300	1N3147	BAW62
1N673	BY127	1N1194A	BYX38-300	1N3182	BA102

type to be replaced	replacement	type to be replaced	replacement	type to be replaced	replacement
1N3189 to 3196	BY126	1N4383	BY126	D 1N5743B	
1N3221	BY127	1N4384	BY126	D 1N5744B	
1N3242	BY127	1N4385	BY127	D 1N5745B	
1N3254	BY126	1N4441	BAW62 1N4148	D 1N5746B	
1N3271	BY127	D 1N4446		D 1N5747B	
1N3279	BY127	1N4447	1N4446	D 1N5748B	
1N3282	BYX10	D 1N4448		D 1N5749B	
1N3283	BYX10	1N4450	BAV10	D 1N5750B	
1N3291 to 3295	BYX32*	1N4454	1N914	D 1N5751B	
1N3309 to 3337	BYZ91*	1N4514	BY127	D 1N5752B	
1N3483	BAV10	1N4531	BAW56	D 1N5753B	
1N3484	AAZ15	1N4532	BAW56	D 1N5754B	
1N3547	BY126	1N4585	BY127	D 1N5755B	
1N3575	BAX18	1N4606	BAV10	D 1N5756B	
1N3592	AAZ18	1N4607	BAV10	D 1N5757B	
1N3593	BAV20 BAX16	1N4610	BAV10	1N36040	BY127
1N3595	BAX15	1N4658 to 4677	BZX61* BZX87*	1P541	AA119
1N3600	BAX12	1N4721 to 4725	BYX48* BYX99*	1P542	AA119
1N3604	BAV10	1N4726	BAV20 BAX16	1S32	OA90
1N3605	BAV10	1N4727	BAV10	1S33	OA90
1N3640	BY126	1N4732 to 4735	BZY96*	1S34	OA90
1N3641	BY127	1N4736 to 4761	BZX61* BZX87*	1S44	BAW62 BAX13
1N3671	BYX42-1200	1N4785	BYX42-300	1S45	BY127
1N3754	BAV21 BAX16	1N4818	BYX38-300	1S47	BY127
1N3756	BY126	1N4820	BYX22-600	1S74	OA95
1N3769	OA95	1N4831 to 4853	BZX61* BZX87*	1S80	OA90
1N3785 to 3790	BZX61* BZX87*	1N4861	BAV20 BAX16	1S83	AAZ15
1N3808	BZY95-C62	1N4940	BAX12	1S84	BY126
1N3809	BZY95-C68	1N4951	BAV20 BAX16	1S90 to 95	BY126
1N3810	BZY95 C75	1N5053	BY127	1S96	BY127
D 1N3880(R)	BYX50-300(R)	1N5055	BA316	1S97	BY127
D 1N3881(R)	BYX50-300(R)	1N5059 to 5062	BY126	1S100	BY126
D 1N3882(R)	BYX50-300(R)	1N5220	BAW62 BAX13	1S101	BY126
D 1N3883(R)	BYX50-300(R)	1N5224	BZX75*	1S107	BY127
D 1N3890	BYX30-200	1N5226 to 5229	BZY88*	1S117	BY127
D 1N3891	BYX30-200	1N5230 to 5267	BZX70*	1S119	BY127
D 1N3892		1N5282	BAV10	1S124	BT127
1N3893	BYX30-400	1N5317	BAV10	1S125	BY127
1N3938	BY127	1N5318	BAV10	1S132	BAX17
1N3939	BY22-600	1N5319	BAV10	1S137	OA90
1N3940	BY127	1N5343	BZY93-C7V5	1S149	BY126
1N4001 to 4008	BY127	1N5344	BZY93-C8V2	1S188	OA95
D 1N4009	BY127	1N5427 to 5430	BAW62 BAX13	1S206	BY127
1N4092	BA218	1N5431	BAV10	1S209	BY127
1N4101 to 4120	BZX79*	1N5432	BAV10	1S315	BY127
1N4149	1N4148	1N5729 to 5757	BZX79*	1S426	OA90
D 1N4150		D 1N5729B		1S446	OA95
D 1N4151		D 1N5730B		1S557	BY127
1N4152	BAV10	D 1N5731B		1S686	BY126
1N4153	BAV10	D 1N5732B		1S920 to 923	BA148
1N4154	BAW62 BAX13	D 1N5733B		1S1007	BAX15
1N4155	BA148	D 1N5734B		1S1625	BY127
D 1N4158	BZX61*	D 1N5735B		1S1692 to 1697	BY127
1N4159 to 4183	BZX61* BZX87*	D 1N5736B		1S3030A	BZX61-C30 BZX87-C30
1N4244	BA182	D 1N5737B		1S7051B	BZX79-C5V1
1N4250	BY127	D 1N5738B		1S021	BYX22-600
1N4324 to 4348	BZX61* BZX87*	D 1N5739B		1S038	BY127
1N4371	BZX75-C2V8	D 1N5740B		1S054	BY127
1N4372	BZX75-C2V8	D 1N5741B		1S058	BY127
1N4376	BAW62 BAX13	D 1N5742B		IT22	OA95

replacement guide for semiconductors

Code letter in front of type number indicates status of product at 1 November 1976 (page 95)

type to be replaced	replacement	type to be replaced	replacement	type to be replaced	replacement
IT23	OA90	2N176	<i>BD181</i>	2N320	AC132
IT508	BY127	2N180	AC132	2N321	AC132
IT2013	BY127	2N181	AC132	2N322	ASY27
IT2015	BY127	2N185	AC132	2N323	ASY27
1WP	BY127	2N186 to 192	AC132	2N324	AC132
1Z7 5 to 75 (E24 range)	BZX61*	2N195 to 199	AC132	2N325	<i>BD181</i>
2G526	ASY80	2N200	AC125	2N326	<i>BD435</i>
2G577	ASY77	2N204	AC125	2N330	AC128
2N27	AC125	2N205	AC125	2N331	AC128
2N28	AC125	2N206	AC125	2N332	BFY50
2N30	AC132	2N207	AC125	2N333	BFY50
2N34	AC132	2N213	AC127	2N334	BFY50
2N36	AC132	2N214	AC127	2N335	<i>BC107</i>
2N37	AC132	2N215	AC126	2N336	<i>BC107</i>
2N38	AC125	2N217	AC132	2N337	<i>BC107</i>
2N39	AC125	2N220	<i>AC125</i>	2N338	BFY50
2N40	AC125	2N222 to 227	AC126	2N341	BF338
2N43	AC128	2N230	<i>BD181</i>	2N342	BFY50
2N44	AC128	2N234	<i>BD181</i>	2N343	BFY50
2N45	AC132	2N235	<i>BD181</i>	2N350	<i>BD181</i>
2N48	AC128	2N236	<i>BD181</i>	2N351	<i>BD181</i>
2N51	AC128	2N238	AC132	2N352	<i>BD181</i>
2N54	AC132	2N239	AC128	2N353	<i>BD181</i>
2N55	AC132	2N240	AC125	2N359	AC132
2N56	AC132	2N241	AC128	2N360	AC132
2N59 to 61	AC128	2N243	BFY55	2N361	AC132
2N62	AC132	2N244	BFY50	2N362	AC125
2N63	AC132	2N250	<i>BD181</i>	2N363	AC125
2N64	AC132	2N255	<i>BD181</i>	2N364	AC127
2N65	AC128	2N256	<i>BD181</i>	2N365	AC127
2N66	<i>BD181</i>	2N257	<i>BD181</i>	2N366	AC127
2N68	<i>BD181</i>	2N258	<i>BD181</i>	2N367	AC128
2N76	AC125	2N260	AC132	2N368	AC132
2N77	AC125	2N262	AC132	2N369	AC128
2N79	AC125	2N265	AC128	2N376	<i>BD181</i>
2N80	AC125	2N266	AC132	2N378	BDX96
2N81	AC126	2N268	BDX96	2N379	BDX92
2N85	AC132	2N269	ASY26	2N380 to 383	AC128
2N86	AC132	2N270	AC128	2N386	BDX96
2N87	AC132	2N271	2N1307	2N387	BDX92
2N88	AC125	2N272	AC128	2N388	2N1308
2N95	AC125	2N273	AC132	2N389	<i>BD181</i>
2N96	AC125	2N279	AC132	2N391	AC128
2N102	<i>BD433</i>	2N280	AC125	2N392	AC128
2N104 to 110	AC125	2N281	AC132	2N394	ASY27
2N111	ASY26	2N283	AC125	2N395	ASY27
2N112	ASY26	2N285	<i>BD181</i>	2N396	ASY27
2N113	2N1307	2N290	<i>BD181</i>	2N397	ASY27
2N114	2N1309	2N291	AC128	2N399	<i>BD181</i>
2N115	<i>BD181</i>	2N296	BDX96	2N400	<i>BD181</i>
2N130	AC125	2N297	BDX96	2N401	<i>BD181</i>
2N131	AC125	2N301	BDX92	2N402	AC132
2N132	AC128	2N302	ASY27	2N403	AC128
2N133	AC128	2N303	ASY27	2N404	AC126
2N138	AC132	2N306	AC127	2N405	AC128
2N141	AC132	2N311	ASY27	2N406	AC128
2N143	AC132	2N315	ASY27	2N407	AC132
2N164	ASY29	2N316	2N1307	2N408	AC128
2N173	BDX92	2N317	2N1309	2N414	ASY27
2N175	AC126	2N319	AC132	2N416	2N1309

type to be replaced	replacement	type to be replaced	replacement	type to be replaced	replacement
2N417	2N1309	2N580	2N1309	2N736	2N2221A
2N419	<i>BD181</i>	2N583	ASY27	2N739	2N2221A
2N420	BDX96	2N586	AC132	2N740	2N2221A
2N422	AC125	2N591	AC126	2N742	2N2221A
2N425	2N1305	2N597	2N1303	2N743	2N2218
					BSX19
2N426	2N1305	2N599	2N 307	2N749	BFY50
2N427	2N1307	2N609	AC132	2N752	2N3553
2N428	2N1309	2N610	AC132	2N753	BSX20
2N438	2N1302	2N611	AC132	2N754	BFY50
2N440	2N1306	2N612	AC132	2N755	2N2218
2N446	AC125	2N613	AC132	2N756	BFY50
2N447	<i>AC127</i>	2N617	ASY27	2N757	BFY50
2N448	ASY29	2N618	BDX96	2N758	BFY50
2N450	ASY27	2N619	BFY50	2N759	2N2222
2N456	BDX96	2N620	BFY50	2N760	2N2483
2N457	BDX96	2N621	BFY50	2N780	<i>BC107A</i>
2N458	BDX96	2N622	AC128	2N783	2N2368
2N462	AC132	2N628	BDX92	2N784	2N2368
2N463	<i>BD181</i>	2N629	BDX96	2N799	2N2368
2N464	AC125	2N631	AC128	2N834	BCY56
2N465	AC125	2N632	AC132	2N839	BFY50
2N466	AC126	2N633	AC128	2N840	BFY50
2N467	AC126	2N634A	2N1304	2N841	BFY50
2N470	BFY55	2N635A	2N1306	2N844	<i>BSX19</i>
2N471	BC107	2N636A	2N1308	2N849	<i>BSX19</i>
2N472	BFY55	2N637	BDX92	2N850	<i>BSX20</i>
2N473	BC109	2N639	BDX92	2N851	<i>BSX19</i>
2N474	BFY50	2N643	2N1309	2N909	2N2483
2N475	BFY50	2N644	2N1309	2N915	2N2221A
2N476	BFY50	2N645	2N1309	2N916	BCY56
2N477 to 480	BFY50	2N656	BFY51	C 2N918	
2N497	BFY51	2N665	BDX96	2N920	<i>BSX19</i>
2N498	BFY51	2N670	AC128	2N927	<i>BSX21</i>
2N502	<i>BCY70</i>	2N680	AC128	2N928	<i>BSX21</i>
2N509	AC132	2N683	BTW45 400R	C 2N929	
2N519	ASY27	2N685	BTW45 400R	C 2N930	
2N520	ASY26	2N687	BTW45 400R	2N943	<i>BFY50</i>
2N521	<i>2N1309</i>	2N695	<i>BC970</i>	2N944	<i>BFY50</i>
2N522	2N1309	2N696	2N1613	2N945	<i>BFY50</i>
2N523	2N1305	2N697	SN1711	2N946	<i>BFY50</i>
2N529 to 533	2N1305	2N702	BC107	2N956	<i>2N1711</i>
2N538	<i>BD181</i>	2N703	BC107	2N978	<i>BCY34</i>
2N539	ASZ15	2N705	BCY72	2N1007	BDX92
2N540	<i>BD181</i>	2N706	BSX19	2N1008	AC128
2N547	BSW67	2N707A	BFY50	2N1009	AC128
2N548	BSW67	2N709	BSX20	2N1010	AC127
2N549	BSW67	2N710	<i>BF196 BD198</i>	2N1011	BDX96
2N553	BDX96	2N711	AC125	2N1014	AC128
2N554	<i>BD181</i>	2N717	BC107	2N1015	<i>BDY20</i>
2N555	<i>BD181</i>	2N718	2N2221A	2N1016	<i>BDY20</i>
2N561	BDX96	2N719	2N1613	2N1017	2N1305
2N563	AC132	2N720	2N2221	2N1021	<i>BD181</i>
2N564	AC132	2N726	<i>BCY72</i>	2N1022	BDX92
2N565	AC132	2N727	<i>BCY72</i>	2N1038	<i>BD181</i>
2N566	AC132	2N728	BSX20	2N1039	BDX92
2N567	AC127	2N729	<i>BF173</i>	2N1040	BDX96
2N568 to 572	AC132	2N730	2N2218	2N1041	BDX96
2N574	BDX92	2N731	2N2221A	2N1042	BDX92
2N575	BDX96	2N733	2N2221A	2N1043	BDX92
2N579	ASY27	2N735	2N2221A	2N1044	BDX96

replacement guide for semiconductors

Code letter in front of type number indicates status of product at 1 November 1976 (page 95).

type to be replaced	replacement	type to be replaced	replacement	type to be replaced	replacement
2N1045	BDX96	2N1316	2N1307	2N1615	2N1711
2N1056	AC128	2N1320	AC128	2N1616	BDY20
2N1059	AC128	2N1322	AC128	2N1617	BDY91
2N1072	BD181	2N1324	AC128	2N1618	BDY90
2N1078	AC125	2N1328	AC128	2N1624	AC127
2N1094	AC128	2N1331	AC128	2N1644	2N2218
2N1097	AC128	2N1340	2N1613	2N1647	BDY20
2N1098	AC128	2N1348	2N1305	2N1648	BDY20
2N1101	AC127	2N1353	AC128	2N1649	BDY20
2N1102	AC127	2N1359	BD181	2N1666	BDY96
2N1128	AC128	2N1370	AC128	2N1667	BDX92
2N1129	AC128	2N1372	AC128	2N1668	BDX92
2N1130	AC128	2N1373	AC127	2N1669	BDX96
2N1136	BDX92	2N1378	AC128	2N1700	BFY50
2N1137	BDX92	2N1379	ASY26	2N1701	BDY20
2N1144	AC128	2N1380	AC128	2N1704	2N2218
2N1145	AC128	2N1381	ASY27	2N1711	
2N1149	BF185	2N1386	2N2219	2N1714	BSX21
2N1159	BDX96	2N1387	2N2219	2N1718	BFS23A
2N1160	BDX96	2N1388	2N2219	2N1719	BFS23A
2N1168	BDX92	2N1390	2N2219	2N1720	2N3632
2N1173	AC127	2N1418	BC107	2N1722	2N3442
2N1176	AC128	2N1420	BFY50	2N1725	BDY20
2N1180	BF196	2N1437	BD181	2N1754	2N1307
2N1183	BD181	2N1438	BD181	2N1760	BDX92
2N1183B	BDX96	2N1468	BD181	2N1761	BDX96
2N1191	2N1305	2N1478	2N1307	2N1773	BTW38 ⁺
2N1193	AC128	2N1479	BFX34	2N1775	BTW38 ⁺
2N1200	BC108	2N1480	BFX34	2N1777	BTY79-400R
2N1208	BDY20	2N1481	BFX34	2N1808	2N1306
2N1212	BDY20	2N1482	BFX34	2N1837	BF115
2N1227	BD181	2N1483	BDY20	2N1838	BF115
2N1241	BSW67	2N1487	BD181	2N1839	BF115
2N1246	AC128	2N1488	BDY20	2N1840	BF115
2N1251	AC127	2N1490	BDY20	2N1843	BTW45-400R
2N1252	2N2218	2N1491	2N2222	2N1844	BTW45-400R
2N1253	2N2218	2N1492	2N2222	2N1846	BTW45-400R
2N1261	BDX96	2N1495	AC128	2N1848	BTW45-400R
2N1262	BDX96	2N1501	BDX96	2N1849	BTY87-400R
2N1263	BDX96	2N1502	BDX92	2N1889	BSW66
2N1276	BF167	2N1505	2N2218A	2N1890	BSW66
2N1278	BF173	2N1506	2N2218	2N1891	2N1304
2N1280	2N1305	2N1507	2N2219	2N1893	2N3019 2N3020
2N1281	2N1307	2N1528	2N2218	2N1907	ASY26
2N1282	2N1307	2N1536	BDX96	2N1936	BDY20
2N1287	AC128	2N1540	BDX92	2N1937	BDY20
2N1291	BDX92	2N1544	BDX92	2N1969	2N1307
2N1293	BDX92	2N1545	BDX96	2N1972	2N2219
2N1295	BDX96	2N1546	BDX96	2N1973	BF179
2N1301	2N1307	2N1564	2N1711	2N1974	BF179
C 2N1302	ASY28	2N1565	2N1613	2N1975	BSX21
C 2N1303	ASY26	2N1566	2N1711	2N1984	BFY50
C 2N1304	ASY28	2N1572	2N1613	2N1985	2N2218
C 2N1305	ASY26	2N1573	2N1613	2N1986	BFY50
C 2N1306	ASY29	2N1574	2N1711	2N1987	BFY50
C 2N1307	ASY27	2N1592	AC187	2N1988	2N1711
C 2N1308	ASY29	2N1599	BTX18-400	2N1989	BFY50
C 2N1309	ASY27	2N1605	2N1308	2N1990	BSX21
2N1314	BD181	C 2N1613		2N1991	2N2904 2N2905
2N1315	BDX92	2N1614	2N1305	2N1993	2N1302

type to be replaced	replacement	type to be replaced	replacement	type to be replaced	replacement
2N1994	2N1302	2N2430	AC127	2N2921	BC548A
2N1995	2N1302	2N2431	AC128	2N2922	BF115
2N1997	2N1307	2N2431MP	2-AC128	2N2923	BC108
2N1998	2N1307	2N2453	BCY87	2N2924	BC108
2N2026	BDY20	2N2475	2N2369A	2N2925	BC109
2N2049	2N1711	2N2476	BSX60	2N2926	BC548A
2N2061 to 2067	BD181	2N2477	BSX60	2N2939	BSX61
2N2068	BDY96	C 2N2483		2N2944	2N2907A
2N2095	BSX19	C 2N2484		2N2945	2N2907A
2N2097	BC327	2N2501	2N2369	2N2946	BC557
2N2102	BFY55	2N2537			
2N2104	2N2905A	2N2538	2N2219	2N2950	2N3375
2N2106	2N2218	2N2539	2N2222	2N2952	BFS23A
2N2107	2N2218	2N2540	2N2222	2N2953	AC128
2N2108	2N2219	2N2586	2N2484	2N2991	BFY55
				2N2993	BFY55
2N2139	BDX92	2N2604	BCY70	2N3009	BSX20
2N2145	BDX96	2N2605	BCY71	2N3010	BSX19
2N2147	BDX92	2N2610	BF167	2N3011	BSX20
2N2148	BDX96	2N2613	AC126	2N3012	BC178B
2N2192	2N2219A	2N2614	AC126	2N3013	BSX20
2N2193	BSX59	2N2692	2N930	2N3014	BSX20
2N2194	2N2218A	2N2693	BCY56	2N3015	2N2218
2N2195	2N1711	2N2694	BCY56	N 2N3019	
2N2196	BSW66	2N2695	BCY72	N 2N3020	
2N2197	BD131	2N2696	BCY72	2N3033	BF177
2N2205	2N2218	2N2706	AC132	2N3034	BF177
2N2217	2N2218	2N1711	BC548A	2N3035	BCY56
D 2N2218		2N2712	BC548A	2N3036	BD139
D 2N2218A		2N2713	BC548A	2N3037	BD139
D 2N2219		2N2714	BC548A	2N3038	BD139
D 2N2219A		2N2717	BCY70	2N3054	BD131
2N2220	2N2221	2N2726	BC148	C 2N3055	BDY20
D 2N2221		2N2787	2N2218	2N3058	BC179
D 2N2221A		2N2790	2N2218	2N3110	BSX20
D 2N2222		2N2835	BD436	2N3118	2N2219
D 2N2222A		2N2836	BD181	2N3123	2N2219
2N2225	2N1305	2N2843	BD181	2N3131	BSX19
2N2243	BSW67	2N2845	2N2222	2N3133	2N2905
2N2256	BC108	2N2846	BSX60	2N3134	2N2905
2N2257	BC108	2N2847	2N2222	2N3153	AC126
2N2271	AC128	2N2848	BSX60	2N3210	BSX19
C 2N2297	BFY55	2N2863	BFY51	2N3115	BD181
2N2303	BFS23A	2N2864	BFY51	2N3223B	2N3772
2N2315	2N2222	2N2865	BF180	2N3236	2N3055
2N2368	BSX19	2N2868	BFY51	2N3241	BFY52
C 2N2369	BSX20	2N2883	BFW17A	2N3248	2N2905
C 2N2369A	2N2884	2N2884	BFW17A	2N3250	2N2905
2N2374	2N1309	2N2890	BSW66	2N3251	2N2905
2N2387	BCY56	2N2891	BSW68	2N3253	BSX59
2N2388	2N930	D 2N2894	BCY72	2N3261	2N2221A
2N2389	2N1613	D 2N2894A			
2N2390	2N1711	D 2N2904		2N3287 to 3294	BC547
2N2393	2N2905A	D 2N2904A			2N2218
2N2394	2N2904	D 2N2905		2N3300	BSX60
2N2395	2N2221A	D 2N2905A		2N3301	2N2222
				2N3302	2N2222
2N2396	2N2221A	D 2N2906		2N3304	BSX20
2N2404	AC125	D 2N2906A		2N3309	2N3866
2N2411	BC178	D 2N2907		2N3327	2N3375
2N2428	AC125	D 2N2907A		2N3338	BSX19
2N2429	AC126	2N2920	2N2483	2N3368	BF245C

replacement guide for semiconductors

Code letter in front of type number indicates
status of product at 1 November 1976 (page 95)

type to be replaced	replacement	type to be replaced	replacement	type to be replaced	replacement
2N3369	<i>BF245B</i>	2N3640	BCY72	2N3964	<i>BCY71</i>
2N3370	<i>BF245A</i>	2N3242	<i>BC337</i>	D 2N3966	
D 2N3375	BCY59	2N3643	2N2218	2N3967	BFW11
2N3390	BC108B	2N3644	<i>BC327</i>	2N3968	BFW12
2N3391	BC548B	2N3645	2N2905A	2N3969	BFW13
2N3392	BC548A	2N3646	BSX20	2N3970	2N4391
2N3393	BC548A	2N3662	2N918	2N3971	2N4392
2N3394	BC548A	2N3663	BFY90	2N3972	2N4393
2N3395	BC548B	2N3664	<i>BFY44</i>	2N4001	BSW66
2N3396	BC548A	2N3680	2N2484	2N4012	2N3632
2N3397	BC548A	2N3684	BFW11	2N4013	2N2222
2N3398	BC548A	2N3685	BFW12	2N4014	2N2222
2N3402	<i>BC338</i>	2N3686	BFW13	2N4026	<i>BD138</i>
2N3403	<i>BC338</i>	2N3687	BFW13	D 2N4030	2N2904A
2N3404	<i>BC337</i>	2N3691	BC548A	D 2N4031	2N2905A
2N3405	<i>BC337</i>	2N3692	BC548A	D 2N4032	2N2905A
2N3414	<i>BC338</i>	2N3693	BC547A	D 2N4033	BD140
2N3415	<i>BC338</i>	2N3694	BC547A	C 2N4036	
2N3416	<i>BC337</i>	2N3702	BC557	2N4037	BD138
2N3417	<i>BC337</i>	2N3703	BC557	2N4040	BLX93
2N3436	<i>B1245C</i>	2N3704	BC337	2N4041	BLX92
2N3437	<i>BF245B</i>	2N3705	BC337	2N4046	2N2219A
2N3438	<i>BF245A</i>	2N3706	BC338	2N4047	BSX59
2N3440	BD115	2N3707 to 3710	BC547A	2N4058	<i>BCY72</i>
M 2N3442		2N3711	BC547B	2N4059	BC558B
2N3443	AC126	2N3712	BD115	2N4060	BC558
2N3444	BSX61	2N3713	2N3055	2N4061	BC558A
2N3450	BFY50	2N3724	BSX60	2N4062	BC558B
2N3458	<i>BF245C</i>	2N3725	BSX59	2N4072	2N2368
2N3459	<i>BF245B</i>	2N3734	BSX60	2N4077	<i>BD433</i>
2N3460	<i>BF245A</i>	2N3735	BSX59	2N4078	<i>BD434</i>
2N3467	BSX61	2N3773	2N3442	2N4079	<i>BD433 BD434</i>
2N3468	BSX59	2N3793	BC337	D 2N4091	
2N3470	BD183	2N3794	BC337	D 2N4092	
2N3485	BCY70	2N3797	<i>BFW10</i>	D 2N4093	
2N3486	BCY71	2N3798	2N2905A	2N4101	BTW38 600R
2N3493	<i>BF173</i>	M 2N3819	BF245A	2N4122	2N2905
2N3499	<i>BFY51</i>	D 2N3823		2N4123	BC547
2N3502	2N2905	2N3825	<i>BC547</i>	2N4124	BC548
2N3503	2N2905A	2N3829	<i>BCY71</i>	2N4125	<i>BC558</i>
2N3504	BCY71	2N3830	<i>BFX34</i>	2N4126	BCY70
2N3505	BCY71	2N3831	BSX59	2N4127	BLY92A
2N3543	<i>BDY20</i>	2N3832	<i>BSX20</i>	2N4128	BLY93A
2N3553		2N3839	BFY90	2N4130	2N3055
2N3554	BSX60	2N3854	<i>BC237</i>	2N4139	<i>BF245B</i>
2N3563	2N918	2N3855	BC107	2N4143	2N2905A
2N3565	<i>BC107A</i>	2N3856	BC109	2N4220	BFW13
2N3566	BCY71	2N3860	BC548A	2N4221	BFW12
2N3569	BC637	D 2N3866		2N4222	BFW11
2N3568	<i>BC337</i>	2N3877	<i>BF337</i>	2N4223	BFW11
2N3576	BSX20	2N3903	BC548A	2N4224	BFW61
BC3605	BSX60	2N3904	2N2222A	2N4235	BFY52
2N3606	2N2369	2N3905	2N2907A	2N4238	BFY50
BC3607	BC548A	2N3906	2N2907A	2N4241	BDX96
2N3615	BDX96	2N3914	2N2906	2N4249	<i>BC556</i>
2N3616	BDX96	C 2N3924		2N4250	<i>BC557</i>
2N3617	BDX92	C 2N3926		2N4254	BF495
2N3622	BDY20	C 2N3927		2N4255	BF495
2N3632		2N3962	2N2907A	2N4264	BC548A
2N3638	2N2904	2N3963	2N2906A	2N4265	BC548A

type to be replaced	replacement	type to be replaced	replacement	type to be replaced	replacement
2N4275	BSX20	2N5036	2N3055	2N5458	BF245B
2N4286	BF196	2N5037	2N3055	2N5459	BF245C
2N4287	BF196	2N5070	BLX13	2N5496	BDY20
2N4289	BC327	2N5071	BLY93A	2N5549	2N4857
2N4302	BF245A	2N5072	BLY90	2N5550	BF337
2N4303	BF245B	2N5083	2N3055	2N5551	BF337
2N4304	BF245B	2N5086	BC557	2N5589	BLY87A
2N4338	BF245A	2N5088	BC547A	2N5590	BLY88A
2N4339	BF245A	2N5089	BC549C	2N5591	BLY89A
2N4340	BF245A	2N5090	2N3375	2N5635	BLX92
2N4341	BF245B	2N5103	BFW12	2N5636	BLX93
M 2N4347		2N5104	BFW12	2N5638	BSV78
D 2N4391		2N5105	BLW11	2N5639	BSV79
D 2N4392		2N5139	BC558	2N5640	BSV80
D 2N4393		2N5142	2N2905	2N5641	BLY91A
2N4400	BC337	2N5148	BSW66	2N5642	BLY92A
2N4401	BC337	2N5152	BSW66	2N5643	BLY93A
2N4402	BC327	2N5163	BF245C	2N5644	BLX67
2N4403	BC327	2N5170	2N3572	2N5645	BLX68
2N4412	2N2905A	2N5172	BC548A	2N5653	BSV78
2N4424	BC337	2N5178	BLX95	2N5654	BSV79
2N4425	BC337	2N5179	BFX89	2N5655	BF338
D 2N4427		2N5197	BFQ11	2N5668	BF245A
2N4428	2N3866	2N5209	BC547A	2N5669	BF245B
2N4429	BLX92	2N5210	BC547B	2N5670	BF245C
2N4430	BLX92	2N5213	BD131	2N5687	BFS22A
2N4431	BLX93	2N5219	BC547B	2N5688	BLY87A
2N4433	BF115	2N5223	BC549	2N5689	BLY87A
2N4434	BF184	2N5240	BDY97	2N5690	BLY89A
2N4435	BF185	2N5262	BFX34	2N5691	BLY89A
D 2N4856		2N5284	BDY90	2N5697	BLX65
D 2N4857		2N5288	BDY90	2N5698	BLX66
D 2N4858		2N5293	2N3055	2N5699	BLX67
D 2N4859		2N5296	BDY20	2N5700	BLX68
D 2N4860		2N5322	2N4036	2N5701	BLX69
D 2N4861		2N5323	2N4036	2N5702	BFS22A
2N4867	BFW13	2N5354	BC328	2N5704	BLY88A
2N4868	BFW12	2N5355	BC328	2N5705	BLY89A
2N4869	BFW11	2N5356	BC328	2N5706	BLY89A
2N4875	BFW16A	2N5358	BFW13	2N5707	BLX13
2N4876	BFW16A	2N5359	BFW12	2N5708	BLX14
2N4910	2N3632	2N5360	BFW12	2N5709	BLX15
2N4911	2N3632	2N5361	BFW11	2N5711	BLX91A
2N4916	2N2905	2N5362	BFW11	2N5712	BLX92A
2N4918	BD132	2N5363	BFW10	2N5713	BLX93A
2N4919	BD138	2N5364	BFW10	2N5714	BLX94
2N4920	BD140	2N5365	BC327	2N5716	BF245A
2N4921	BD131	2N5366	BC327	2N5717	BF245B
2N4922	BD137	2N5367	BC327	2N5718	BF245C
2N4923	BD139	2N5369	2N2222	2N5773	BLX91
2N4933	BLY93A	D 2N5415		2N5774	BLX93
2N4951	BC337	D 2N5416		2N5776	BLX95
2N4952	BC337	2N5421	BD135	2N5801	2N4858
2N4953	BC337	2N5422	BD135	2N5802	2N4857
2N4954	BC338	2N5447	BC328	2N5803	2N4856
2N4977	BSV78	2N5448	2N2907	2N5847	BLY87A
2N4978	BSV79	2N5449	2N2222	2N5848	BLY88A
2N4979	BSV80	2N5450	2N2222	2N5849	BLY89A
2N5006	BD183	2N5451	2N2222	2N5862	BLY94
2N5035	BDY20	2N5457	BF245A	2N5913	BLX65

replacement guide for semiconductors

Code letter in front of type number indicates
status of product at 1 November 1976 (page 95)

type to be replaced	replacement	type to be replaced	replacement	type to be replaced	replacement
2N5914	BLX67	2SA561	BC327	2SB74	AC125
2N5915	BLX68	2SA565	BC327	2SB75	AC125
2N5916	BLX92	2SA566	<i>BD238</i>	2SB76	AC126
2N5917	BLX92	2SA578	BC177	2SB77	AC132
2N5918	BLX93	2SA666	BC549	2SB78	AC126
2N5922	BLX92	2SA671	BD438	2SB79	AC128
2N5923	BLX92	2SA672	BC557	2SB80	<i>BD181</i>
2N5924	BLX93	2SA673	BC327	2SB83	<i>BD181</i>
2N5941	BLX14	2SA677	BC328	2SB84	<i>BD181</i>
2N5942	BLX15	2SA678	BC327	2SB89	AC128
2N5949	BF245C	2SA683	<i>BC327</i>	2SB90	AC125
2N5950	BF245C	2SA704	BC328	2SB91	AC132
2N5951	BF245B	2SA705	BC327	2SB92	AC128
2N5952	BF245B	2SA715	BD234	2SB94	AC128
2N5953	BF245A	2SA719	BC328	2SB95	AC128
2N5992	BLY93A	2SA730	BC328	2SB96	AC128
2N5993	BLY88A	2SB12	AC125	2SB97	AC126
2N5994	BLY94	2SB13	AC128	2SB98	AC125
2N5995	BLY87A	2SB16	<i>BD181</i>	2SB99	AC125
2N5996	BLY88A	2SB17	<i>BD181</i>	2SB100	AC125
2N6050	BDX64	2SB19	<i>BD434</i>	2SB101 to 105	AC128
2N6051	BDX64A	2SB20	<i>BD434</i>	2SB106 to 109	<i>BD181</i>
2N6052	BDX64B	2SB22	AC132	2SB110	AC125
2N6053	BDX62	2SB23	AC128	2SB111	AC125
2N6054	BDX62A	2SB26 to 2SB31	<i>BD181</i>	2SB112	AC132
2N6055	BDX63	2SB32	AC125	2SB113 to 117	AC125
2N6056	BDX63A	2SB33	AC128	2SB118	<i>BD181</i>
2N6057	BDX65	2SB34	AC128	2SB119	<i>BD181</i>
2N6058	BDX65A	2SB37	AC128	2SB120	AC125
2N6059	BDX65B	2SB38	AC128	2SB122	BDX96
2N6080	BLX67	2SB39	AC126	2SB123	BDX92
2N6081	BLY88A	2SB40	AC126	2SB124	BDX96
2N6082	BLY89A	2SB41	<i>BD181</i>	2SB125	BDX92
2N6083	BLY89A	2SB43	AC188	2SB126	<i>BD434</i>
2N6084	BLW60	2SB44	AC128	2SB127	<i>BD181</i>
2N6136	BLX69	2SB46	AC125	2SB128	BDX96
2N6197	BLY91A	2SB47	AC125	2SB129	BDX96
2N6198	BLY92A	2SB48	AC125	2SB131	<i>BD181</i>
2N6199	BLY93A	2SB49	AC132	2SB134	AC125
2N6200	BLY94	2SB50	AC132	2SB135	AC125
2N6201	BLY94	2SB51	AC128	2SB136	AC128
2N6202	BLX92	2SB52	AC128	2SB137	<i>BD181</i>
2N6203	BLX93	2SB53	AC132	2SB140	BDX92
2N6205	BLX95	2SB54	AC125	2SB141	BDX96
2N6206	BLX92	2SB55	AC128	2SB142 to 146	<i>BD181</i>
2N6207	BLX94	2SB56	AC132	2SB147	BDX96
2N6282	BDX67	2SB57	AC128	2SB148	BDX96
2N6283	BDX67A	2SB58	AC132	2SB149	BDX92
2N6284	BDX67B	2SB59	AC126	2SB153	AC125
2N6285	BDX66	2SB60	AC128	2SB154	AC132
2N6286	BDX66A	2SB61	AC132	2SB155	AC128
2N6287	BDX66B	2SB62	<i>BD181</i>	2SB156 to 160	AC128
2S18	<i>BD181</i>	2SB63	<i>BD181</i>	2SB161	AC125
2SA261	BF196 BF198	2SB65	AC125	2SB162	AC128
2SA262	BF196 BF198	2SB66	AC125	2SB163	AC128
2SA263	BF196 BF198	2SB68	ASY77	2SB164	AC128
2SA264	BF196 BF198	2SB69	BSX92	2SB165	AC125
2SA527	<i>BD234</i>	2SB70	AC126	2SB166	AC128
2SA547	BD236	2SB71	AC126	2SB167	AC128
2SA550	BC159	2SB73	<i>AC125</i>	2SB168	AC126

type to be replaced	replacement	type to be replaced	replacement	type to be replaced	replacement
2SB169	AC128	2SB345	AC126	2SC16	BC108
2SB170	AC125	2SB346	AC126	2SC17	BC108
2SB171	AC125	2SB347	AC126	2SC21	2N3055
2SB172	AC132	2SB348	AC126	2SC23C	BD137
2SB173	AC125	2SB364	AC128	2SC27	2N2218
2SB174	AC128	2SB365	AC128	2SC29	2N1613
2SB175	AC126	2SB367	BD434	2SC33	2N1613
2SB176	AC128	2SB368	BD434	2SC34	AC187
2SB178	AC128	2SB370	AC128	2SC35	AC187
2SB179	AC128	2SB371	AC128	2SC36	2N1308
2SB180	BD181	2SB376	AC128	2SC39A	BC108
2SB181	BD181	2SB377	AC126	2SC40	BF115
2SB183	AC126	2SB378	AC125	2SC41	BDY20
2SB184	AC125	2SB379	AC126	2SC42A	BDY20
2SB185	AC125	2SB380	AC126	2SC43	BDY20
2SB186	AC125	2SB382	BC179	2SC44	BDY20
2SB187	AC125	2SB383	BC179	2SC50	2N1308
2SB188	AC128	2SB389	AC128	2SC53	BF115
2SB189	AC128	2SB400	AC128	2SC55	BSX20
2SB190	AC125	2SB405	AC188 01	2SC56	BSX19
2SB191	AC125	2SB407	BDX92	2SC70	BF336
2SB192	AC125	2SB411	BD181	2SC71	2N1308
2SB193 to 200	AC128	2SB414	BD181	2SC72	2N1308
2SB201	AC126	2SB415	AC128	2SC73	BF173
2SB202	AC128	2SB424	BDX96	2SC75	BF173
2SB219 to 227	AC128	2SB425	BDX96	2SC76	BF173
2SB228	BDX96	2SB426	BDX92	2SC77	BF173
2SB229	BDX96	2SB439	AC125	2SC80	BC108
2SB232	BDX96	2SB440	AC128	2SC99	BC108
2SB242	BD434	2SB443	AC188	2SC100	2N1613
2SB246	BD434	2SB444A	AC128	2SC108	2N1711
2SB247	BD434	2SB445	BD181	2SC120	2N1711
2SB248	AC128	2SB448	BD181	2SC121	2N1711
2SB249	BDX96	2SB449	BD181	2SC122	2N2369
2SB250	BD181	2SB452	AC125	2SC123	BC547
2SB251	BD181	2SB459	AC128	2SC124	2N1711
2SB252A	BDX96	2SB462	BDX96	2SC129	2N1308
2SB253	BDX96	2SB463	BD434	2SC131	BF196 BF198
2SB254	AC125	2SB465	BDX96	2SC150	BFY50
2SB255	AC128	2SB466	BD181	2SC154	BF336
2SB257	AC125	2SB467	BD181	2SC155	BC108
2SB261	AC125	2SB470	AC132	2SC156	BC108
2SB262	AC125	2SB471	BDX92	2SC160	BF184
2SB263	AC128	2SB472	BDX96	2SC172	BSX20
2SB264	AC125	2SB473	BD434	2SC173	2N1308
2SB271	AC128	2SB474	BD132	2SC174A	BF200
2SB282	BDX96	2SB475	AC128	2SC175 to 178	2N1308
2SB283	BDX92	2SB481	BD434	2SC179	AC187
2SB284	BDX92	2SB482	AC128	2SC180	AC187
2SB285	BDX96	2SB486	AC128	2SC181	2N1308
2SB303	BC179	2SB492	BD434	2SC182	BC108
2SB304	AC125	2SB493	BDX92	2SC183	BF115
2SB317	AC128	2SB494	AC188	2SC184	BF115
2SB325	AC126	2SB495	AC188	2SC185	BC108
2SB329	AC125	2SB496	AC188	2SC186	BF196
2SB336	AC126	2SB497	AC128	2SC187	BF196
2SB337	BDX92	2SB512A	BD238	2SC188	2N2218
2SB339	BDX96	2SB513A	BD238	2SC189	2N2218A
2SB340	BDX96	2SC13	AC127	2SC191 to 194	2N1711
2SB341	BDX96	2SC14	2N1308	2SC196	BSX20

replacement guide for semiconductors

Code letter in front of type number indicates status of product at 1 November 1976 (page 95)

type to be replaced	replacement	type to be replaced	replacement	type to be replaced	replacement
2SC197	BFY51	2SC468	BSX19	2SC717	BF181
2SC199	2N1711	2SC470	BF336	2SC728	BF337
2SC204	BSX19	2SC477	BF184	2SC733	BC547
2SC206	BC107	2SC478	BC547	2SC735	BC107
2SC220	BFY51	2SC479	BFY50	2SC736	2N3055
2SC221	BFY52	2SC482	2N1711	2SC738	BSX20
2SC222	BSW67	2SC485	BF337	2SC761	BF180
2SC228	2N1613	2SC490	BD235	2SC762	BF180
2SC233	2N1711	2SC493	BDY20	2SC772	BF198
2SC237	BSX20	2SC494	BDY20	2SC773	BC337
2SC242	2N3055	2SC509	BFY51	2SC781	BF180
2SC266	BC108	2SC511	BFX34	2SC784	BF199
2SC269	BFX44	2SC535	BF183	2SC785	BF199
2SC271	BF183	2SC536	BC547	2SC793	BDY20
2SC273	2N1711	2SC537	BC548	2SC804	BFY90
2SC281	BC107	2SC538	BC547	2SC805	BSW66
2SC282	BFY50	2SC539	BC549	2SC806	BDY98
2SC283	2N1613	2SC540	BC109	2SC807	BDY98
2SC284	2N1711	2SC542	2N3632	2SC814	BC338
2SC287	BF183	2SC549	2N3632	2SC815	BC337
2SC288	BF183	2SC550	2N3927	2SC826	2N1711
2SC289	BFY90	2SC561	BSX20	2SC828	BC547
2SC291	BD115	2SC562	BF167	2SC829	BF494
2SC292	BD115	2SC563	2N1613	2SC830	BD237
2SC293	BD115	2SC587	BC547	2SC838	BC547
2SC297	BD131	2SC588	2N1711	2SC840	2N3055
2SC298	BD131	2SC605	2N1613	2SC856	BF337
2SC298S	BD115	2SC611	BFY90	2SC857	BF337
2SC299	BD131	2SC614	BD237	2SC858	BC548
2SC299S	BD15	2SC619	BC548	2SC867	BU133
2SC313	BFY90	2SC620	BC337	2SC870	BC547
2SC316	BC107	2SC629	BF183	2SC871	BC545
2SC318	BC107	2SC631	BC547	2SC894	BC548
2SC320	BC107	2SC632	BC547	2SC895	BU133
2SC321	BC337	2SC633	BC547	2SC897	BDY90
2SC352	2N2218	2SC634	BC547	2SC899	BC547
2SC353	2N2218	2SC641	BC547	2SC907	BC107
2SC360	BC107	2SC644	BC549	2SC917	BF336
2SC362	BC548	2SC645	BF184	2SC918	BF199
2SC366	BC337	2SC646	2N3055	2SC926	BF336
2SC367	BC337	2SC647	2N3055	2SC929	BF494
2SC368	BC107	2SC648	BC548	2SC930	BF494
2SC369	BC547	2SC649	BF495	2SC931	BD437
2SC371 to 374	BC547	2SC650	BF495	2SC932	BD433
2SC375	BFX44	2SC656	BSX20	2SC935	BU126
2SC377	BC547	2SC657	BF199	2SC937	BU205
2SC379	BC107	2SC668	BF199	2SC947	BF181
2SC380	BF199	2SC680	BU33	2SC948	BF183
2SC401 to 404	BC547	2SC682	BF199	2SC957	BFX44
2SC408	2N1613	2SC683	BF180	2SC984	BC337
2SC429	BF200	2SC684	BF181	2SC1000	BC547
2SC430	BF200	2SC685	BU126	2SC1012	BF336
2SC454	BF494	2SC689	BSX20	2SC1013	BD233
2SC458	BC547	2SC693	BC547	2SC1014	BD233
2SC460	BF185	2SC696	BD237	2SC1018	BD237
2SC461	BF184	2SC697	2N3055	2SC1030	BDY90
2SC463	BF180	2SC707	BF180	2SC1034	BU205
2SC464	BF185	2SC710	BF494	2SC1047	BF198
2SC465	BF185	2SC711	BC547	2SC1055	BDY90
2SC466	BF185	2SC715	BC547	2SC1056	BF338

type to be replaced	replacement	type to be replaced	replacement	type to be replaced	replacement
2SC1060	BD437	2SD120	BD235	3NU40	AC125
2SC1061	BD437	2SD124A	2N3055	3NU70	AC125
2SC1086	BU208A	2SD127	AC127	3T508	BY127
2SC1117	BF180	2SD128	AC127	4/10	OA95
2SC1123	BFX44	2SD130	BD235	4/12	OA95
2SC1126	BFX44	2SD141	2N3055	4T508	BY127
2SC1128	BFX44	2SD142	2N3055	5/61	OA95
2SC1129	BF199	2SD143	2N3632	5/62	OA95
2SC1162	BD233	2SD146	AC127	5A8	BY127
2SC1172	BU108	2SD147	2N3632	5E4	BY126
2SC1174	BU208	2SD150	BD131	5E8	BY127
2SC1204	BC547	2SD154	BDY20	5J180	AA119
2SC1205	BF494	2SD157	BU126	5J180E	OA90
2SC1212A	BD237	2SD167	AC127	5MA8	BY127
2SC1213	BC337	2SD168	AC127	5RC10A	BTW38*
2SC1214	BC337	2SD170	AC187	5RC20A	BTW38
2SC1215	BF183	2SD173	2N3055	5RC30A	BTW38*
2SC1226A	BD235	2SD174	BD182	10/2	BY126
2SC1317	BC338	2SD176	2N3055	10B2	BYX38-300
2SC1318	BC337	2SD178	AC127	10B8	BYX38-1200
2SC1327	BC547	2SD180	2N3055	10D1	BY126
2SC1328	BC547	2SD186	AC187	10D2	BY126
2SC1335	BC549	2SD187	AC127	10D4	BY126
2SC1342	BF494	2SD189	2N3055	10D6	BY127
2SC1346	BC338	2SD193	AC127	10J2	BY126
2SC1347	BC337	2SD195	AC187	10J2F	BY126
2SC1359	BF494	2SD198	BU126	10R2(R)	BYX38-300(R)
2SC1360	BF199	2SD199	BU132	10W2	BYX32-600
2SC1398	BD235	2SD200	BU205	11J2	BY126
2SD24	BU126	2SD201	2N3055	11J2F	BY126
2SD25	AC127	2SD203	BDY20	11Z4	BZY88-C4V3
2SD28	BD437	2SD226A	BD235	11Z6	BZY88-C3V3
2SD29	BD237	2SD234	BD437	12J2	BY126
2SD30	AC127	2SD235	BD437	12J2F	BY126
2SD33	AC127	2SD261	BC337	12P2	BAX17
2SD34	AC127	2SD290	2N3055	12Z6	BZY88-C3V6
2SD35	AC187	2SD291	BD235	13J2	BA148
2SD36	AC187	2SD292	BD235	13J2F	BY126
2SD37	AC127	2SD299	BU208A	13P1	AAZ18
2SD38	AC127	2SD300	BU208A	13P2	BAX15
2SD43	AC187	2SD317A	BD237	13RC10A	BTW45-400R
2SD44	AC187	2SD318A	BD237	13RC20A	BTW45-400R
2SD45	BDY20	2SD334	2N3055	13RC30A	BTW45-400R
2SD46	BDY20	2T11 to 17	AC128	13Z4	BZX79-C5V1
2SD47	BDY20	2T20 to 26	AC128	13Z6	BZY88-C3V9
2SD53	2N3055	2T13	AC128	14J2	BY126
2SD56	BU133	2T14	AC128	14J2F	BY126
2SD61 to 66	AC127	2T3030 to 3033	BD181	14P1	AAZ17
2SD72	AC187	2T3041	BD181	14P2	BAX16
2SD75	AC127	2T3042	BD181	14Z4	BZX79-C7V5
2SD77	AC127	2T3043	BD181	14Z6	BZY88-C4V3
2SD82	2N3055	3N34	BC109	15J2	BY126
2SD83	BDY90	3N35	BC108	15P1	AAZ15
2SD91	2N3055	3N56	AC187	15P2	BAV10
2SD92	2N3055	3N57	AC187	15R2	BYX25-600
2SD96	AC187/01	3N83	BRV39	15Z4	BZX79-C9V1
2SD100	AC127	3N84	BRV39	15Z6	BZX79-C4V7
2SD104	AC127	3N87	BC107	16A	BD181
2SD105	AC128	3N88	BC107	16J2	BYX10
2SD118	2N3442	3N128	BSV81	16J2F	BYX10

replacement guide for semiconductors

Code letter in front of type number indicates status of product at 1 November 1976 (page 95)

type to be replaced	replacement	type to be replaced	replacement	type to be replaced	replacement
16P1	BA218	41P1	AA119	145T1	<i>BD181</i>
16P2	<i>BAV10</i>	41Z4	BZZ24	146T1	<i>BD181</i>
16RC10	BTW45 400R	41Z6	<i>BZX79-C9V1</i>	180T2A	2N3055
16RC20	BTW45 400R	42J2	BAX18	180T2B	2N3055
16RC30	BTW45 400R	42R2	BYX48 300	325T1	BC177
16RC70	BTW45 400R	42R6	BYX36 150	406Z4	BZX79 C6V2
16Z4	<i>BZX79 C12</i>	42Z6	<i>BZX79-C9V1</i>	409Z4	BZX79 C9V1
16Z6	<i>BZX79 C5V1</i>	43P1	AC125	412Z4	BZX79 C12
17P1	AAZ15	43Z6	<i>BZX79-C10</i>	442CE	<i>BD181</i>
17P2	BA218	44P1	AA119	536J2	BY126
17Z4	<i>BZX79 C12</i>	44P2	<i>BAX16 BAV20</i>	536J2F	BY126
17Z6	<i>BZX79 C5V6</i>	44R2(R)	BYX38 600(R)	537J2	BY126
18J2	<i>BY127</i>	44T1	AC128	537J2F	BY126
18J2F	<i>BY127</i>	45J2	BAV18	538J2F	BY126
18P2	<i>BAV10</i>	45P1	<i>BAX16 BAV20</i>	539J2F	BY126
18Z6	<i>BZX79 C6V2</i>	45P2	<i>BAX16 BAV20</i>	540J2F	BY126
19P1	OA90	46P1	AA119	547J2F	BY126
19P2	<i>BAV10</i>	46P2	<i>BAV18</i>	610C	BA218
19Z6	<i>BZY96 C6V8</i>	47P2	<i>BAX16 BAV20</i>	612C	BA218
20A	<i>BD181</i>	48P2	<i>BAV18</i>	1075Z4F	BZX61 C7V5 BZX87 C7V5
20Z6	<i>BZX61 C7V5</i>	50D8	BY127	1085Z4	BZX61 C10 BZX87 C10
21Z6	<i>BZX61 C8V2 BZX87 C8V2</i>	50E8	BY127	1095J2	BY127
22P1	BAW62	50J2	BY127	1095J2F	BY127
22Z6	<i>BZX61 C9V1 BZX67 C9V1</i>	50J4	BA148	1095Z4F	BZX61 C10 BZX87 C10
23J2	<i>BYZ10</i>	52J2	BA148	1096J2	BY127
23Z6	<i>BZX61 C10 BZX87 C10</i>	57Z4	BZZ23 BZZ24	1096J2F	BY127
24J2	<i>BAX16 BAV10</i>	61J2	BY126	1101	<i>BZX75-C2V8</i>
24Z6	<i>BZX61 C11 BZX87 C11</i>	61SV	BA148	1102	<i>BZY88 C3V3</i>
25J2	BAX16	62J2	BA148	1103	<i>BZY88 C3V9</i>
25P1	AAZ15	63J2	BA148	1104 to 1133	BZX79
25Z6	<i>BZX61 C12 BZX87 C12</i>	64J2	BY127	1305	BZX61 C5V6 BZX87 C5V6
26A	<i>BD181</i>	65J2	BY127	1306	BZX61 C6V8 BZX87 C6V8
26J2	OA200 BAV18	66J2	BY127	1307 to 1339	<i>BZX61 BZX87</i>
26Z6	<i>BZX61 C13 BZX87 C13</i>	67J2	BYX10	1343	<i>BZX61 C43 BZX87 C43</i>
27A	<i>BD181</i>	71RC10A	BTW23 600R	1347	<i>BZX61 C47 BZX87 C47</i>
27J2	BAX16	71RC20A	BTW23 600R	5320 to 5341	BZX61 BZX87
28A	BDX96	71RC30A	BTW23 600R	5508 to 5511	<i>BZX88</i>
28J2	OA200	71RC40A	BTW23 600R	5512 to 5541	<i>BZX79</i>
28Z6	<i>BZX61 C15 BZX87 C15</i>	71RC50A	BTW23 600R	7706	<i>BZX75 C2V8</i>
29A	BDX92	71RC60A	BTW23 600R	7707	<i>BZX75 C2V8</i>
29P1	BAV19	71RC70A	BTW23 800R	7708	<i>BZX75-C3V6</i>
30P4	BAV10	71RC80A	BTW23 800R	7709	<i>BZX75-C3V6</i>
31Z6	<i>BZY88 C3V3</i>	71RE60	BTW23 600R	7710 to 7713	<i>BZY88</i>
32Z6	<i>BZY88 C3V3</i>	71RE70	BTW23 800R	7714 to 7741	BZX61 BZX87
33Z6	<i>BZY88 C3V9</i>	71RE80	BTW23 800R	8121	BZX79 C12
34P1	AAZ18	71Z4	BZY91 C10	8560	BZX79 C5V6
34P4	<i>BAW62 BAX13</i>	75D8	BY127	9971	BZX88 C3V6
34PA4	BA218	75E8	BY127	9972	BZY88 C4V3
34Z6	<i>BZY88 C4V3</i>	80AS	BY127	9973	BZX79 C5V1
35Z6	<i>BZX79 C4V7</i>	80H	BY127	9983	BZX61 C5V1 BZX87 C5V1
36Z6	<i>BZX79-C5V1</i>	82T1	<i>BD181</i>	9984	BZX61 C6V2 BZX87 C6V2
37Z6	<i>BZX79 C5V6</i>	111Z4	BZX61 BZX87	40235	<i>BC108A</i>
39Z6	<i>BZX79 C4V7</i>	112Z4	BZX61 BZX87	40305	2N3553
40J2K	BY126	113Z4	BZX61 BZX87	40307	2N3632
40P1	AA119	114Z4	BZX61* BZX87	40312	<i>BD131</i>
40Z4	BZZ29	115Z4	BZX61 BZX87	40360	BD140
40Z6	<i>BZX79-C7V5</i>	134P4	BAW62	40361	BD139
41HF20	BYX97 300	135P4	BAW62	40362	BD140
41HF60	BYX97 900	136P4	<i>BAW62</i>	40406	BD138
41HF80	BYX97 1200	137P4	BAW62	40408	BD139